

APPENDIX 9
TO THE GENERAL CONTRACT OF USE (GCU) FOR
WAGONS

Technical Conditions
for Wagon Transfers
between Railway Undertakings

Applicable with effect from 1 July 2006

(Former Appendix XII to RIV 2000, applicable with effect from 1 November 2002)

-reserved-

INTRODUCTION

Former Appendix XII to the RIV, which entered force on 1 November 2002, was transposed into the GCU, brought up to date and re-published as Appendix 9 (to the GCU).

A vertical line in the margin denotes amended provisions taking effect on the date shown at the foot of the page.

This Appendix 9 enters force with the GCU (see date on title page). Appendix XII to the RIV is withdrawn on the same date.

Amendments			
Supplement		Supplement	
No.	Date	No.	Date
Supplement 1	31/01/2008		
Supplement 2	01/01/2012		
Supplement 3	01/01/2013		
Supplement 4	01/01/2014		
Supplement 5	01/01/2015		
Supplement 6	01/01/2016		
Supplement 7	01/01/2017		
Supplement 8	01/01/2018		
Supplement 9	01/01/2019		
Supplement 10	01/01/2020		
Supplement 11	01/01/2021		
Supplement 12	01/01/2022		

CONTENTS

1. GENERAL	6
2. TECHNICAL TRANSFER INSPECTION	6
2.1 DEFINITION	6
2.2 PROCEDURE	6
2.3 SKILLS OF STAFF PERFORMING TECHNICAL TRANSFER INSPECTIONS	6
3. CATALOGUE OF IRREGULARITIES (ANNEX 1)	7
3.1 PRESENTATION	7
3.2 COMMENTS ON THE CATALOGUE OF IRREGULARITIES	7
4. QUALITY MANAGEMENT SYSTEM (QMS)	8
4.1 GENERAL DEFINITIONS	8
4.2 PLANNING OF QUALITY	8
4.3 IRREGULARITIES AND CATALOGUE OF IRREGULARITIES	8
4.4 PLANNING OF TESTS	8
4.5 QUALITY CONTROL	8
4.6 INSPECTION METHODS	9
4.7 ASSESSMENT OF IRREGULARITIES	9
4.8 ANALYSIS OF RESULTS	9
4.9 CORRECTIVE MEASURES	10
5. INCLUSION OF A TRAIN IN AN AGREEMENT	10
5.1 GENERAL	10
5.2 PRINCIPLES, PLANNING, EXECUTION	11
5.3 EXCLUSION OF TRAINS FROM AN AGREEMENT	12
Annex 1	Catalogue of irregularities including classification into classes for use in the Quality Management System
Annex 2	Irregularity classes
Annex 3	Size of samples as per ISO 2859 – Part 1 Excerpt from Table 2-A with acceptance values for irregularity classes 4 and 5 Overview I: Procedure for the inclusion of a train in an agreement Overview II: Procedure for the exclusion of trains from an agreement Record of the inclusion of trains in an agreement
Annex 4	Verification of qR
Annex 5	Catalogue of inspections in accordance with Annex 1
Annex 6	Technical transfer inspection – List of irregularities noted on wagons and their loads

- Annex 7 Technical transfer inspection – Record and analysis of irregularities noted on wagon and loads
- Annex 8 Handling of wagons
- Annex 9 Checklists
- Annex 10 Positions of the brake stopcock handle for compressed air brakes
- Annex 11 I, K, M, R1 and U labels
- Annex 12 Traceability

1. GENERAL

1.1 **Annex 1** of this appendix sets out binding provisions governing the technical condition of wagons exchanged between two or more railway undertakings (RUs), as established during a technical transfer inspection.

1.2 It describes (in point 4 and Annexes 5, 6 and 7) a quality assurance procedure to be applied by RUs that have signed agreements governing the technical conditions for the exchange of freight wagons.

2. TECHNICAL TRANSFER INSPECTION

2.1 DEFINITION

2.1.1 Transfer inspection

The term “technical transfer inspection” shall refer to:

- a technical inspection upon handover conducted by the transferor RU,
- a technical inspection upon acceptance conducted by the transferee RU,
- a technical inspection conducted at a different location from the handover point (conducted by the transferor RU).

2.1.2 Date/time of handover and acceptance

The date/time of the handover/acceptance marks the transfer of custody of the vehicles in the sense of article 22.1. The location and date/time shall be agreed on. In the absence of an agreement, acceptance counts as the moment of transfer of custody.

2.2 PROCEDURE

The technical transfer inspection shall be carried out by qualified staff at a place agreed upon by the RUs involved.

The inspection shall involve assessing the operating safety and railworthiness of wagons, identifying any of the irregularities listed in **Annex 1** (Catalogue of irregularities) and taking appropriate steps. To identify any irregularities, the qualified staff shall walk the full length of the train on both sides and carefully examine each wagon.

2.3 SKILLS OF STAFF PERFORMING TECHNICAL TRANSFER INSPECTIONS

All safety-related examinations from Appendix 9, **Annex 1** must be performed by properly qualified technical staff.

This staff must have the following minimum qualifications:

- General knowledge of rail vehicle maintenance,
- General knowledge of rail vehicle design and operation,
- General knowledge of brake design and operation,
- Ability to appraise technical damage and irregularities occurring on wagons and loads and their impact on operations,

- Knowledge of the UIC Loading Guidelines,
- Knowledge of regulatory documents concerning the exchange of vehicles between railway undertakings (RUs) and the related agreements in force.

The staff must receive training in order to acquire the above-mentioned skills and must update said skills regularly.

The required skills include theoretical and practical knowledge.

3. CATALOGUE OF IRREGULARITIES (ANNEX 1)

3.1 PRESENTATION

Annex 1 contains five columns:

- (1) List of wagon components and aspects of the load to be examined,
- (2) Code number,
- (3) Irregularities, where appropriate with criteria and indications to facilitate detection. Possible means of recognising irregularities are marked “•” without this being a requirement to execute the measures,
- (4) Action to be taken,
- (5) Irregularity class.

3.2 COMMENTS ON THE CATALOGUE OF IRREGULARITIES

3.2.1 All the dimensions (values) quoted should be measured in cases of doubt.

3.2.2 The provisions of the Loading Guidelines (published separately) remain fully applicable.

In this connection, qualified staff shall particularly look out for the irregularities listed under section 7 of the catalogue (**Annex 1**), column (3) of which contains cross-references in brackets to the relevant points of Volume 1 of the Loading Guidelines. Qualified staff shall also watch out for other visible signs that the load or load securing equipment is compromising operating safety and shall take appropriate action.

3.2.3 To help locate irregularities and defects, qualified staff shall use stick-on labels (see specimens in **Annex 11**) and shall, in written correspondence, quote the code number specified in column (2) of **Annex 1**.

3.2.4 This appendix is not an exhaustive catalogue of all the irregularities which might occur. Where there are other irregularities not listed in this document, but which might well compromise operating safety or the wagon's railworthiness, qualified staff shall take whatever action they deem necessary. Such irregularities are to be documented by means of the superordinate code applicable in context to the part/components/aspect in question and are to be assigned to at least the second grouping level.

3.2.5 The expression “Detach wagon” means that the wagon may not continue its onward conveyance if it presents an irregularity that could impact on the safety of operations.

3.2.6 Once detached, the wagon remains in the custody of the user RU which recorded the irregularity whilst the irregularity is being rectified.

4. QUALITY MANAGEMENT SYSTEM (QMS)

4.1 GENERAL DEFINITIONS

Use of a quality management system (QMS) provides a guarantee of quality for wagon exchanges between RUs. The aim is to determine a set standard of technical quality by means of representative spot checks in accordance with ISO standard 2859. This technical quality must be formally set out in writing and the RUs must take all necessary action to maintain or improve it.

4.2 PLANNING OF QUALITY

Quality requirements and characteristics are defined during the planning phase and are set out in detail in the catalogue of inspections. The quality target agreed between RUs is to obtain a cumulative defect value (CDV) of $\leq 1\%$ for each class of irregularity.

4.3 IRREGULARITIES AND CATALOGUE OF IRREGULARITIES

4.3.1 An irregularity is defined as any deviation from the quality criteria defined in the catalogue if as a consequence of this deviation the equipment or train in question does not conform to the set requirements. Equipment on which irregularities have been noted must be dealt with in accordance with the catalogue of irregularities in Appendix 9 to the GCU (**Annex 1**).

4.3.2 Description of irregularities

Irregularities are classified as minor, major or critical, according to their seriousness, and are defined in **Annex 2**.

4.3.3 In addition to listing the various kinds of damage / irregularity and the corresponding action to be taken, the catalogue of irregularities (**Annex 1**) also indicates the category to which each irregularity belongs.

4.3.4 Irregularities not listed in this document, but which might well compromise operating safety or the wagon's railworthiness must be assigned to irregularity class 3 at least.

4.4 PLANNING OF TESTS

The number of wagons to be inspected, referred to as the "inspection batch", shall be determined from the "overall batch", which includes all wagons handed over by one RU to other RUs (including via one or more transit RUs) in a given calendar year. The overall batch may be divided into partial batches, for example according to specific routes or handover points. From this overall batch (or corresponding partial batches) is determined an "inspection batch", as specified in ISO standard 2859 (**Annex 3**) which is then incorporated into the annual inspection schedule as a theoretical inspection batch. When dividing up into partial inspection batches defined on a monthly basis, account should be taken where possible of annual trends in the changing number of wagons.

When determining the inspection batch, inspection level II should be applied.

4.5 QUALITY CONTROL

The conformity of the technical transfer inspections shall be measured by the transferee RU during the spot-checks. These checks shall be carried out at the latest at the first marshalling yard at which technical inspections are conducted or at the station where the

train consist is disconnected or re-formed by the transferee RU. Quality checks shall be carried out before the train is disconnected or re-formed, in accordance with the procedure of qualified staff described in point 2.2.

4.6 INSPECTION METHODS

The inspection methods referred to in the catalogue (**Annex 5**) have the following meanings:

- VC = visual check inspection with naked eye
- M = measurement inspection based on measurement
- HT = hammer test inspection involving hammer blows
- OP = operate operating test
- PM = pull or move actuation of the part in question

4.7 ASSESSMENT OF IRREGULARITIES

Defects and irregularities already dealt with by the RU that carried out the transfer inspection by applying the measures indicated in the catalogue of irregularities (**Annex 1**) are not to be considered as irregularities. If a wagon has been labelled by the RU that carried out the technical transfer inspection, only the irregularities that are not mentioned on the label may be taken into account for calculating the CDV value. Identical irregularities that occur on several sub-components (such as stanchions) are considered in principle as one irregularity per wagon or per load unit. The same applies to load residues and/or load securing equipment that has not been removed. Where irregularities on a given component or load have been given different classifications, only the irregularity in the higher class should be recorded.

4.8 ANALYSIS OF RESULTS

4.8.1 It is the type of irregularity rather than its frequency of occurrence which is the decisive factor in evaluating the number of irregularities within the context of the quality management system. Each type of irregularity has a serial number in the Catalogue of Irregularities (**Annex 1**).

4.8.2 Cumulative defect value (CDV)

The CDV value, which is used as a means of measuring the defective nature of the inspection batches, is calculated as a percentage of irregularities per hundred control units. To this end, the irregularities are assigned to a class, depending on their impact on fitness for use in service and on operating safety, as follows:

- Class 3 factor of 0.125/1
- Class 4 factor of 0.4/1
- Class 5 factor of 1/1

The CDV value for each class of irregularity is then calculated using the following formula:

$$\text{CDV Class 3 [\%]} = \frac{0.125 \times \Sigma \text{ Class 3 irregularities} \times 100}{\text{Number of units checked}}$$

$$\text{CDV Class 4 [\%]} = \frac{0.4 \times \Sigma \text{ Class 4 irregularities} \times 100}{\text{Number of units checked}}$$

$$\text{CDV Class 5 [\%]} = \frac{1.0 \times \Sigma \text{ Class 5 irregularities} \times 100}{\text{Number of units checked}}$$

4.8.3 The irregularities recorded shall be sent each month to the RU that carried out the technical transfer inspection using the lists given in **Annexes 6** and **7**, indicating the type of overall batch and the quantity of units inspected for each CDV. The information described in **Annexes 6** and **7** can be exchanged in a variety of ways and by electronic means in particular.

4.9 CORRECTIVE MEASURES

If the quality target specified in point 4.2 above is not achieved, the RU that carried out the technical transfer inspection, must take corrective measures to improve the standard of quality. The transferee RU shall immediately inform the transit RU(s), where appropriate. The RU that carried out the technical transfer inspection shall notify the transferee RU and where appropriate the transit RU(s) of the action taken within one month.

With effect from the implementation of these measures, a representative sample must be selected each month, in order to show the resulting improvements.

If necessary, the transferee RU may, in agreement with the transit RU(s) as appropriate, exclude certain wagons (or wagons with a particular load) when forming the trains in question.

5. INCLUSION OF A TRAIN IN AN AGREEMENT

5.1 GENERAL

This procedure is recommended to RUs that are planning to conclude agreements.

The procedure does not apply if all the trains exchanged between two RUs are covered by the agreement.

In order to include trains in an agreement, independently of a cumulative defect value, RUs shall apply a procedure based on DIN/ISO 2859 (Sampling procedures for inspection by attributes – Sampling schemes indexed by **Acceptance Quality Limit (AQL)**).

However, trains may only be included in an agreement if acceptability is achieved over a defined period of time for a specific batch (in this case a train).

Table 2-A (Simple sampling guidelines for standard inspections, see **Annex 3**) offers clear criteria for determining the acceptability of inspection batches (in this instance, trains). Once the acceptability of the train has been established, the RU inspecting the handover and quality shall send the participating RUs an inspection report in accordance with **Annex 3** for signature.

The participating RUs are to be informed of any irregularities noted during the control period.

Following their inclusion in the agreement, these trains must nonetheless meet the agreed quality target of a CDV $\leq 1\%$ for each class of irregularity.

The procedures for the carriage of dangerous goods (RID) shall be dealt with separately.

5.2 PRINCIPLES, PLANNING, EXECUTION

In this procedure, the following principles apply:

- Irregularity classes 5 and 4 shall be considered separately (class 3 shall not be considered initially);
- An AQL defined in accordance with DIN/ISO 2859 as the “Number of defects per 100 control units” shall be applied;

For a K defect (Class 5) which is evaluated on a 1:1 basis, an AQL of 1.0 is equivalent to one defect per 100 control units and for an H defect (Class 4) which is evaluated on a 0.4:1 basis, an AQL of 2.5 is equivalent to one defect per 100 control units.

- The inspection/control period for a given train should be at least three months;
- Each month at the interface between RUs, the quality of the transfer shall be determined by spot-checks with the required sample size and the results documented in a test protocol;
- The inclusion of a given train shall only be accepted if, over the inspection period/control period, the acceptance value specified in Table 2-A DIN/ISO 2859 (**Annex 3**) for classes 5 and 4 is not exceeded.

This procedure is shown in Overview I, **Annex 3**.

5.2.1 Example

Train	12345
Days of operation	7
Average number of wagons	32
Wagons per year	11648
Wagons over the inspection period (3 months)	2912
Batch size as per Annex 3 , Table 1, Inspection level II	1201 – 3000
Code letter calculated	K
Sample size as per Annex 3 , Table 2-A	125
Inspections per month	42
Acceptance value for class 5 (AQL 1.0) as per Annex 3 , Table 2-A	3
Acceptance value for class 4 (AQL 2.5) as per Annex 3 , Table 2-A	7

5.2.2 Results of the inspection

a) After 125 inspections, the following was observed:

1 defect in class 5, 9 defects in class 4.

Train 12345 cannot be included in an agreement since the acceptance value for class 4 was exceeded during the inspection period.

The inspection period is extended by at least one more month.

b) After 125 inspections, the following was observed:

4 defects in class 5, 3 defects in class 4.

Train 12345 cannot be included in an agreement since the acceptance value for class 5 was exceeded during the inspection period.

The inspection period is extended by at least one more month.

If the acceptance values for classes 5 or 4 are exceeded by a substantial amount, a new 3-month inspection period is recommended.

5.3 EXCLUSION OF TRAINS FROM AN AGREEMENT

The procedure is set out in overview II, **Annex 3**.

APPENDIX 9, ANNEX 1

Catalogue of irregularities including classification into classes for use in the Quality Management System

CONTENTS

- 1 Running gear**
- 2 Suspension**
- 3 Brake**
- 4 Wagon underframe and bogie frame**
- 5 Buffing and draw gear**
- 6 Wagon body**
 - 6.1 Wagon body in general
 - 6.2 Covered wagons
 - 6.3 Open wagons
 - 6.4 Flat wagons
 - 6.5 Tank wagons
 - 6.6 Wagons with special fittings
 - 6.7 Gear for securing load units (ILU) on carrier wagons
- 7 Loads and intermodal loading units (ILU)**
 - 7.1 Load in general
 - 7.2 Load securing equipment
 - 7.3 Loading and load securing methods
 - 7.4 Special types of consignment
 - 7.5 Specific components ILU
 - 7.6 ILU tank
 - 7.7 Loading of ILU
 - 7.8 Marking, coding
- 8 Particular incidents**
 - 8.1 Operating irregularities
 - 8.2 Other events

-reserved-

Component	Code no.	Irregularities/Criteria/Notes	Action to be taken	Irregularity class
Running gear	1			
Tyred wheel	1.1	Thickness less than:		
	1.1.1	– 35 mm on wagons suitable for running at 120 km/h (SS wagons or wagons marked “**”) – 30 mm on other wagons ¹	Detach wagon	4
	1.1.2	Tyre – broken – cracked lengthways or crossways	Detach wagon	5
	1.1.3	Tyre loose – inspection marks inconsistent or – unclear ring or – tyre clip loose or – appearance of rust between the tyre and the rim over more than one third of the circumference	Detach wagon	5
	1.1.4	Inspection marks – missing – not clearly discernible	Detach wagon	4
	1.1.5	Tyre shifted sideways – tyre clip loose or visibly distorted	Detach wagon	5
	1.1.6	Damage to tyre clip – cracked – broken – missing	Detach wagon	5

¹ Including wagons that can only be operated at 120 km/h when empty

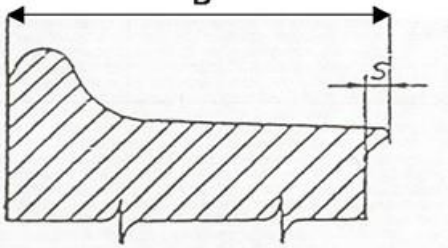
Component	Code no.	Irregularities/Criteria/Notes	Action to be taken	Irregularity class
Solid wheel	1.2 1.2.1	Groove marking the minimum thickness is no longer fully visible in cross-section ²	Detach wagon	4
	1.2.2	Thermal overload due to braking <ul style="list-style-type: none"> obviously recent paint burns of 50 mm or more at connection between rim and wheel plate (cracks or shelling on paint) traces of rust on rim (plate not painted) fusion of brake blocks deterioration of wheel tread with build-up of metal (see also no. 1.3.4) Uneven blueish appearance on rim due to the effect of thermal overload 	Proceed in accordance with Annex 8, point 4	
	1.2.2.1	– without gauge widening of the inner faces	K + R1 (isolate brake)	4
	1.2.2.2	– with gauge widening of the inner faces	Detach wagon	5
	Tyre or corresponding part of solid wheel	1.3 1.3.1 1.3.1.1	Width Width B > 139 mm and ≤ 140 mm	M
1.3.1.2	Width B > 140 mm < 133 mm <ul style="list-style-type: none"> presence of a projection (“S”) 	Detach wagon	4	
1.3.2	Tread crushed in places, uneven contact surfaces or irregular protrusions on the wheel rim.	Detach wagon	4	

² The outer groove indicates the minimum thickness (wear groove) should a wheel – as an exception – have two grooves.

Component	Code no.	Irregularities/Criteria/Notes	Action to be taken	Irregularity class
Tyre or corresponding part of solid wheel (continued)	1.3.3	Wheel flat		
	1.3.3.1	– wheel $\varnothing > 840$ mm, wheel flat > 60 mm long	Detach wagon	4
	1.3.3.2	– wheel \varnothing : $630 \text{ mm} < d \leq 840$ mm, wheel flat > 40 mm long	Detach wagon	4
	1.3.3.3	– wheel $\varnothing \leq 630$ mm, wheel flat > 35 mm long	Detach wagon	4
	1.3.4	Build-up of metal		
	1.3.4.1	– wheel $\varnothing > 840$ mm, metal build-up over a length of > 60 mm or ≥ 1 mm thick	Detach wagon	4
	1.3.4.2	– wheel $\varnothing > 840$ mm and metal build-up over a length of > 10 mm ≤ 60 mm and < 1 mm thick	M + R1 (isolate brake)	3
	1.3.4.3	– wheel \varnothing : $630 \text{ mm} < d \leq 840$ mm and metal build-up over a length of > 40 mm or ≥ 1 mm thick	Detach wagon	4
	1.3.4.4	– wheel \varnothing : $630 \text{ mm} < d \leq 840$ mm and metal build-up over a length of > 10 mm ≤ 40 mm and < 1 mm thick	M + R1 (isolate brake)	3
	1.3.4.5	– wheel $\varnothing \leq 630$ mm and metal build-up over a length of > 35 mm or ≥ 1 mm thick	Detach wagon	4
	1.3.4.6	– wheel $\varnothing \leq 630$ mm and metal build-up over a length of > 10 mm ≤ 35 mm and < 1 mm thick	M + R1 (isolate brake)	3
	1.3.5	Cavity, shelling or flaking		
	1.3.5.1	– wheel $\varnothing > 840$ mm, length > 60 mm	Detach wagon	4
	1.3.5.2	– wheel \varnothing : $630 \text{ mm} < d \leq 840$ mm, length > 40 mm	Detach wagon	4
	1.3.5.3	– wheel $\varnothing \leq 630$ mm, length > 35 mm	Detach wagon	4
	1.3.6	Cracks and notches		
1.3.6.1	Cracks at the interface between the wheel tread and the front edge	Detach wagon	5	

Component	Code no.	Irregularities/Criteria/Notes	Action to be taken	Irregularity class
Tyre or corresponding part of solid wheel <i>(continued)</i>	1.3.6.2	Sharp-angled notches on the front face (rim or inner tyre rim) caused by tools, track brakes or clamping equipment/ jaws – except for markings applied by the manufacturer	K	4
	1.3.6.3	Cracks on the tread - isolated cracks <ul style="list-style-type: none"> • Without characteristics of thermal overload 	K + R1 (isolate brake)	4
	1.3.6.4	<ul style="list-style-type: none"> • With characteristics of thermal overload 	Detach wagon	5
	1.3.7	Deposits of paint, oil or lubricants on wheel tread edge, except for <ul style="list-style-type: none"> – control marks (4 paint marks positions 90° apart) – friction modifiers 	Detach wagon	5
	1.3.8	Formation of grooves, hollows/furrows, false flanges (hollows) ³ on the wheel tread		
	1.3.8.1	Grooves with sharp edges < 1 mm deep	K + R1 (isolate brake)	4
	1.3.8.2	Grooves with sharp edges ≥ 1 mm deep	Detach wagon	5
	1.3.8.3	Furrows and false flanges > 2 mm deep	Detach wagon	5

³ **Grooves** appear on the entire circumference of the wheel and may affect the whole width of the wheel tread; they are characterised by transitions to sharp edges. **Hollows/furrows** appear on the entire circumference of the wheel and may affect the whole width of the wheel tread; they are characterised by a rounded contour, with no transition to sharp edges. **False flange**: there is a false flange when the outer part of the wheel tread is higher than the wheel tread at the level of the tread section

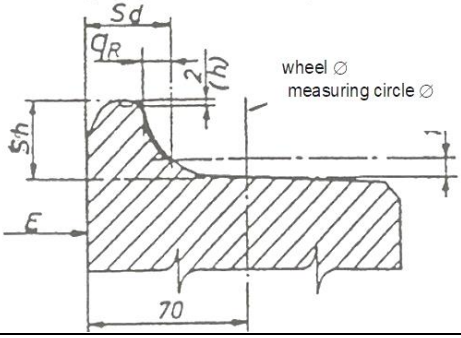
Component	Code no.	Irregularities/Criteria/Notes	Action to be taken	Irregularity class
Flange	1.4 1.4.1	Height of flange S_h greater than 36 mm <ul style="list-style-type: none"> hollow on wheel tread Wagon with LL brake blocks and permissible speed greater than 100 km/h Height of wheel flange S_h greater than 32 mm <ul style="list-style-type: none"> Hollow on wheel tread 	Detach wagon	4
	1.4.2	Flange thickness S_d – wheel $\varnothing > 840$ mm $S_d < 22$ mm – wheel $\varnothing: 760 \text{ mm} \leq d \leq 840$ mm $S_d < 25$ mm – wheel $\varnothing < 760$ mm $S_d < 27.5$ mm Wagons with LL or K brake blocks – wheel $\varnothing > 330$ mm $S_d > 33$ mm <ul style="list-style-type: none"> worn flange 	Detach wagon	5
	1.4.3	Wear of guide faces – $qR \leq 6.5$ mm (see Annex 4) <ul style="list-style-type: none"> sharp flange 	Detach wagon	5
	1.4.4	Burrs or sharp edges on guide face at a distance $h > 2$ mm from maximum height of flange (see also Annex 4) 	Detach wagon	5
Wheel centre	1.5 1.5.1	Solid wheel Damage to wheel centre or wheel hub – cracked – defect repaired by welding	Detach wagon	5

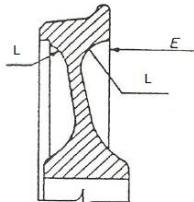
Component	Code no.	Irregularities/Criteria/Notes	Action to be taken	Irregularity class
Wheel centre <i>(continued)</i>	1.5.2	Tyred wheel Damage to wheel centre, tyre clip, tyre – cracked – broken – defect repaired by welding	Detach wagon	5
Axle	1.6 1.6.1	Damage to axle – cracked – deformed (see also no. 1.7.1) – defect repaired by welding – sharp edge – worn to a depth of more than 1 mm	Detach wagon	5
	1.6.2	Worn to a depth of ≤ 1 mm, no sharp edges	K + R1 (isolate brake)	4
	1.6.3	Part rubbing against axle Also check nos. 1.6.1 and 1.6.2	Tie up + K, if necessary R1 (isolate brake). If not possible, detach wagon	4
Wheelset	1.7 1.7.1	Clearance E between internal faces non-compliant with the following limit values: – $\varnothing > 840$ mm $1357 \text{ mm} \leq E \leq 1363 \text{ mm}$ – $\varnothing \leq 840$ mm $1359 \text{ mm} \leq E \leq 1363 \text{ mm}$ If in all cases, $E_{\text{max}} - E_{\text{min}} > 2 \text{ mm}$ • signs of derailment • signs of movement of wheel on axle • heating (solid wheel) in “L” fillet zone between web and rim/tyre 	Detach wagon	5

Component	Code no.	Irregularities/Criteria/Notes	Action to be taken	Irregularity class
<p>Signs of out-of-round wheels</p>	<p>1.7.2</p>	<p>Brake triangle pin sheared off</p> <p>Brake safety stirrup broken (see also no. 3.1.2)</p> <p>Shiny traces on the brake triangle end washer</p> <p>Shiny traces on the inner spring (load spring) (see also no. 2.5)</p> <p>Lifting safety catch ("T") missing or loose (see also no. 2.5.5)</p> <p>Y25 bogies: hard manganese wear plates on axle boxes or axle-box guides have fallen off or welded joints loose (see also no. 1.8.4 and 4.4.2)</p> <p>Tread crushed in places, uneven contact surfaces or irregular protrusions on the wheel rim (see also no. 1.3.2)</p>	<p>If at least two of these signs are noted on or near a wheel:</p> <p>K + add comment "Suspected out-of-round wheel"</p>	<p>4</p>

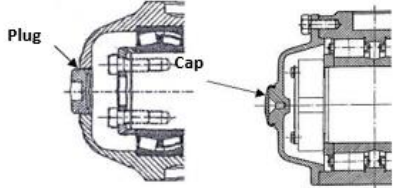
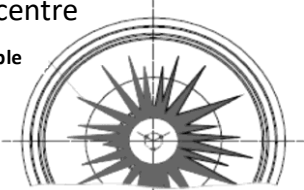
Component	Code no.	Irregularities/Criteria/Notes	Action to be taken	Irregularity class
Axle box	1.8			
	1.8.1	Housing		
	1.8.1.1	Housing not watertight Defect allowing water or dust to enter <ul style="list-style-type: none"> – cracked or broken housing – missing plug (NB: the loss of the protective cover of the centring cone is permissible) – except housing types without cover 	Detach wagon	4
	1.8.1.2	Loss of lubricant <ul style="list-style-type: none"> • grease or oil discharge on the wheel centre not permissible 	Detach wagon	4
	1.8.1.3	<ul style="list-style-type: none"> • trace of grease or oil in the area of the housing cover 	K	4
	1.8.2	Axle box guides no longer able to guide the axle <ul style="list-style-type: none"> • guide broken • axle box in abnormal position 	Detach wagon	5
	1.8.3	Hot box		
1.8.3.1	– housing too hot to touch with back of hand <ul style="list-style-type: none"> • traces of rust 	Detach wagon	5	
1.8.3.2 ⁴	Confirmation by the RU of box over-heating during transport	Detach wagon	5	
Hard manganese wear plate on axle box of Y bogie or derivative designs	1.8.4	Displaced or missing	Detach wagon	4

⁴ Hot box: Observation by automatic detection – Observation outside the scope of TI by special inspection.

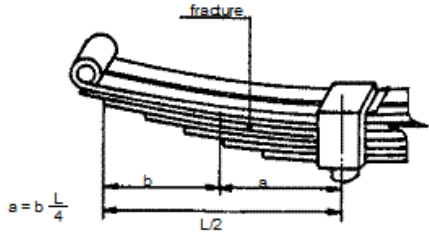
Component	Code no.	Irregularities/Criteria/Notes	Action to be taken	Irregularity class
Suspension	2			
Leaf spring	2.1			
	2.1.1	Leaves displaced by more than 10 mm with respect to buckle <ul style="list-style-type: none"> shiny marks near buckle 	Detach wagon	4
	2.1.2	Main leaf fractured or with visible crack	Detach wagon	5
	2.1.3	Part of a fractured spring missing	Detach wagon	4
	2.1.4	Fracture (but without any part missing) of intermediate leaf at a distance from the centre of the spring of:		
	2.1.4.1	of: <ul style="list-style-type: none"> < $\frac{1}{4}$ of leaf length 	Detach wagon	4
	2.1.4.2	– > $\frac{1}{4}$ of leaf length	M	3
		 <p style="text-align: center;">$a = b \frac{L}{4}$</p>		
2.1.5	Insufficient spring clearance: <p>Vertical distance between buckle and fixed parts of body, underframe or bogie frame less than 15 mm</p> <ul style="list-style-type: none"> signs of recent contact between buckle and fixed parts of the underframe or bogie frame signs of recent contact between wheel and underframe or wagon floor/body 	Detach wagon	5	
2.1.6	Buckle loose <ul style="list-style-type: none"> fracture of crack in buckle key missing or ineffective signs of loosening of leaves 	Detach wagon	5	

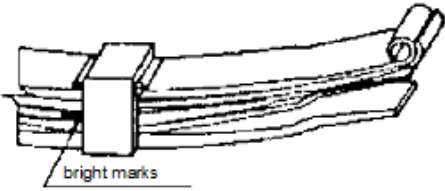
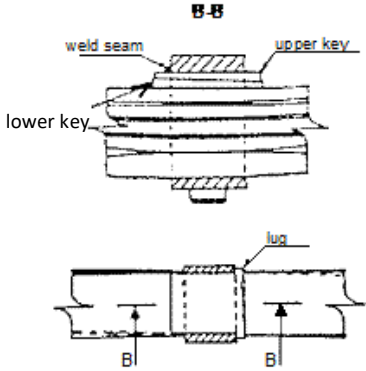
Component	Code no.	Irregularities/Criteria/Notes	Action to be taken	Irregularity class
Additional criteria for parabolic spring	2.2			
	2.2.1	Main or intermediate spring leaf		
	2.2.1.1	visible crack or break	Detach wagon	5
	2.2.1.2	Buckle broken <ul style="list-style-type: none"> • two leaves touching over 50 % of their length 	Detach wagon	5
	2.2.2	Leaf displaced lengthways		
	2.2.2.1	– by more than 10 mm	Detach wagon	4
	2.2.2.2	– by 10 mm or less <ul style="list-style-type: none"> • shiny marks near buckle 	K	3
2.2.3	Buckle damaged or loose <ul style="list-style-type: none"> – buckle fractured, cracked – lug of the lower key cracked – weld seam of upper key fractured or cracked 	Detach wagon	5	

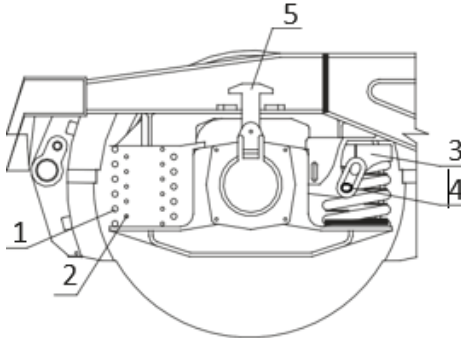
Component	Code no.	Irregularities/Criteria/Notes	Action to be taken	Irregularity class
Helical spring	2.3			
	2.3.1	Broken	Detach wagon	5
Connection between suspension and axle box or between suspension and bogie frame	2.4			
	2.4.1	Boss of buckle out of position <ul style="list-style-type: none"> • abnormal position of axle box 	Detach wagon	5
	2.4.2	Shackle, links displaced, missing, broken, unhooked	Detach wagon	5
	2.4.3	Link pin displaced, missing, not secured	Rectify. If not possible, detach wagon	5
	2.4.4	Suspension links worn or too long <ul style="list-style-type: none"> • recent traces of contact on the solebar 	K	4
Suspension system of Y 25 bogies or derived systems	2.5	 <p>1. Tare spring 4. Damper ring 2. Load spring 5. Lifting T 3. Spring cap</p>		
	2.5.1	Main/tare spring cracked or broken	Detach wagon	5
	2.5.2	Auxiliary/load spring displaced or broken		
	2.5.2.1	– on empty wagon	K	3
	2.5.2.2	– on loaded wagon <ul style="list-style-type: none"> • axle box no longer horizontal 	Detach wagon	5
	2.5.3	Damper ring(s) missing or broken <ul style="list-style-type: none"> • contact marks 		
	2.5.3.1	– one ring per bogie	K	3
	2.5.3.2	– more than one ring per bogie	Detach wagon	5

Component	Code no.	Irregularities/Criteria/Notes	Action to be taken	Irregularity class
Suspension system of Y 25 bogies or derived systems <i>(continued)</i>	2.5.4	Spring cap(s) in contact with bogie frame		
	2.5.4.1	– one spring cap in contact with bogie	K	3
	2.5.4.2	– more than one spring cap in contact per bogie	Detach wagon	5
	2.5.5	Lifting T (safety catch) loose or missing	M	3
	2.5.6	Insufficient spring clearance: Vertical distance between axle-box housing and bogie frame less than 8 mm <ul style="list-style-type: none"> • Recent signs of contact between axle-box housing and bogie frame 	Detach wagon	5

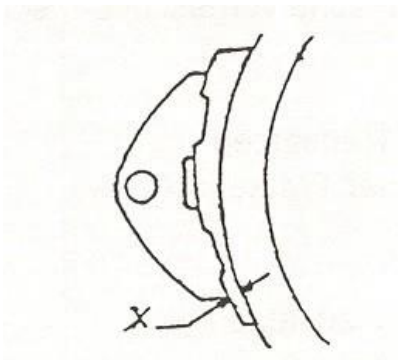
Component	Code no.	Irregularities/Criteria/Notes	Action to be taken	Irregularity class
Brake	3			
Mechanical part (rigging)	3.1			
	3.1.1	Parts of brake rigging hanging down or broken Check also 1.6.1, 1.6.2, 1.6.3	Temporary repair, K + R1 (isolate brake)	4
	3.1.2	Safety strap ineffective	Temporary repair, K	4
	3.1.3	Brake isolating cock (see also Annex 10)		
	3.1.3.1	– unusable	Detach wagon	3
	3.1.3.2	– position unclear	K + R1 (isolate brake), detach wagon if necessary	3
	3.1.4	Empty/loaded or G/P changeover system unusable	K + R1 (isolate brake)	3
3.1.5	Brake release pull broken or missing	K + R1 (isolate brake)	3	
Brake block	3.2			
	3.2.1	Cast-iron brake block – missing – broken, cracked right through, even if still held together by its metal insert – worn so that thickness X near brake block is less than 10 mm 	Replace. If not possible, K + R1 (isolate brake)	3

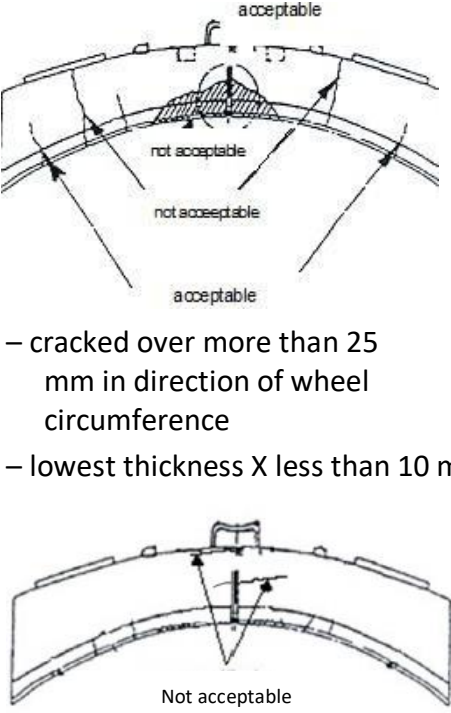
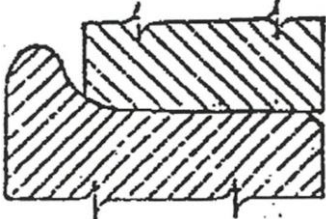
Component	Code no.	Irregularities/Criteria/Notes	Action to be taken	Irregularity class
<p>Brake block <i>(continued)</i></p>	<p>3.2.2</p>	<p>Composite brake block</p> <ul style="list-style-type: none"> – missing – radial crack from friction surface through to plate edge (except at the designated expansion joint) <p>Friction material:</p> <ul style="list-style-type: none"> – visible crumbling of the friction material over more than one quarter of the block length, or metal inclusions – detached from back plate by more than 25 mm  <ul style="list-style-type: none"> – cracked over more than 25 mm in direction of wheel circumference – lowest thickness X less than 10 mm 	<p>Replace. If not possible, K + R1 (isolate brake)</p>	<p>3</p>
	<p>3.2.3</p>	<p>Brake block protruding</p> <ul style="list-style-type: none"> • a brake block is considered to be protruding once its outer surface reaches the outer edge of the wheel rim 	<p>K + R1 (isolate brake)</p>	<p>4</p>

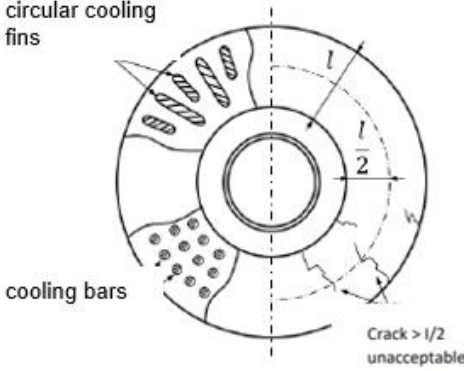
Component	Code no.	Irregularities/Criteria/Notes	Action to be taken	Irregularity class
Disc brakes* * Observed during a special inspection separate to the technical inspection	3.2.4			
	3.2.4.1	The inspection groove on the brake discs is no longer completely visible (maximum wear)	K + R1 (isolate brake)	3
	3.2.4.2	Defective brake disc fixing on the axle pin	Detach wagon	5
	3.2.4.3	Brake disc: unacceptable cracks > l/2 as per diagram circular cooling fins  cooling bars	K + R1 (isolate brake)	3
	3.2.4.4	Crack in cross-section	Detach wagon	5
	3.2.4.5	Missing or cracked cooling bars – more than 2 side by side – more than 6 in total	K + R1 (isolate brake)	3
	3.2.4.6	Cracked circular cooling fins – more than 4, with less than 3 cooling lines intact between the cracked fins	K + R1 (isolate brake)	3
	3.2.5	Brake linings – missing – cracked	K + R1 (isolate brake)	3
Brake indicator	3.2.6	Defective or brake indicator data not true to the status of the brake or display not synchronous with the indicator (other than indications relating to the handbrake)	K + R1 (isolate brake)	4

Component	Code no.	Irregularities/Criteria/Notes	Action to be taken	Irregularity class
Pneumatic part	3.3			
	3.3.1	Main brake pipe		
	3.3.1.1	Main brake pipe inoperative	Detach wagon	4
	3.3.1.2	- reserved -		
	3.3.2	Brake coupling		
	3.3.2.1	Damaged or missing (brake couplers must be available at all existing coupler connections on either end of a wagon)	Replace	3
	3.3.2.2	Unused brake coupler hanging loose (where two couplers are available, only one may be plugged in)	Secure, rectify as appropriate	3
	3.3.2.3	- reserved -		
	3.3.3	Brake coupler hold not fit for use	M	3
	3.3.4	Air brakes unfit for use but not labelled as such	Check and, if damaged, K + R1 (isolate brake)	3
	3.3.5	Stopcock		
	3.3.5.1	Unusable, leaking, warped or handle missing	Detach wagon	5
	3.3.5.2	Stopping device missing or visibly damaged	Rectify + K. If not possible, detach wagon	4
	3.3.6	DET (derailment detector)		
	3.3.6.1	Derailment detector tripped	Rectify + M, proceed according to point 5 of Annex 8	3
3.3.6.2	Detector not airtight	Isolate detector + M, proceed according to point 5 of Annex 8	3	
3.3.6.3	Detector's connection hose not airtight	Rectify + M, if not possible, remove	4	

Component	Code no.	Irregularities/Criteria/Notes	Action to be taken	Irregularity class
Spark arrestor plate	3.4			
	3.4.1	Plate missing or rusted through	K + R1 (isolate brake)	4
	3.4.2	Plate hanging loose	Remove plate, K + R1 (isolate brake), if not possible, detach wagon	4
	3.4.3	<p>Consignments of dangerous goods for which spark arrestor plates are stipulated in the RID</p> <p>Non-bogie wagon</p> <p>– non-standard spark arrestor plate</p> <ul style="list-style-type: none"> • non-bogie wagon not bearing the following marking 	R1 (isolate brake)	5
Hand brake	3.5			
	3.5.1	Clearly unfit for use	K + R1	3

Component	Code no.	Irregularities/Criteria/Notes	Action to be taken	Irregularity class
Wagon underframe and bogie frame	4			
Wagon underframe	4.1 4.1.1	Underframe warped vertically or horizontally <ul style="list-style-type: none"> • buffer height out of tolerance range (see no. 5.1.2) • visible distortion 	Detach wagon	5
	4.1.2	Solebar, headstock stressed by coupler or intermediate crossbar exhibiting a fracture or crack <ul style="list-style-type: none"> – fracture – lateral crack starting from edge of flange and extending over more than half the width of flange – longitudinal crack > 100 mm near suspension brackets – longitudinal crack > 150 mm for other parts – cracking at visible welds of these component parts 	Detach wagon	4
Axle guard	4.2 4.2.1	Distorted, safety hazard	Detach wagon	5
	4.2.2	Broken <ul style="list-style-type: none"> • abnormal position 	Detach wagon	5
	4.2.3 4.2.3.1	Fastening <ul style="list-style-type: none"> – loose 	Detach wagon	5
	4.2.3.2	– some bolts or rivets loosened but axle guard still secure	M	3
	4.2.4 4.2.4.1	Crack <ul style="list-style-type: none"> – running over more than $\frac{1}{4}$ of horizontal cross-section 	Detach wagon	4
	4.2.4.2	– running over $\leq \frac{1}{4}$ of horizontal cross-section	K	3
	4.2.4.3	– close to or running towards a fastening point, regardless of length of crack	Detach wagon	5

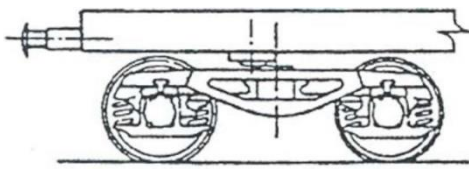
Component	Code no.	Irregularities/Criteria/Notes	Action to be taken	Irregularity class
Axle guard tie bar	4.3			
	4.3.1	Missing, broken, visibly distorted, loose	Detach wagon	4
Axle guard check plate	4.4			
	4.4.1	Check plate missing Bogie wagon		
	4.4.1.1	– one check plate missing per axle	K	3
	4.4.1.2	– more than one check plate missing	Detach wagon	4
	4.4.1.3	Axle wagon – one check plate missing	Detach wagon	5
Hard manganese wear plate on Y bogies or derivative designs	4.4.2	Plate displaced or missing	Detach wagon	4
Suspension bracket (axle wagon)	4.5			
	4.5.1	Loose, cracked, broken, or distorted – space between bracket and sole-bar – half or more of the fastening elements missing or broken	Detach wagon	5
Connection between bogie and underframe	4.6			
	4.6.1			
	4.6.1.1	Defective, connecting and fastening elements broken, missing or ineffective • bogie displaced 	Detach wagon	5
	4.6.1.2	Locking device for the bogie pivot kingpin missing or ineffective or pin missing	Detach wagon	4

Component	Code no.	Irregularities/Criteria/Notes	Action to be taken	Irregularity class
Earthing strap	4.6.2			
	4.6.2.1	One or more earthing straps ineffective (missing, damaged or loose) <ul style="list-style-type: none"> Fastening points indicate that straps should be present 	K	3
	4.6.2.2	All earthing straps ineffective <ul style="list-style-type: none"> Fastening points indicate that straps should be present 	Rectify. If not possible, detach wagon	3
Bogie frame	4.7			
	4.7.1	Component cracked or visibly distorted	Detach wagon	4
	4.7.2	Component broken	Detach wagon	5
	4.7.3	Bogie frame assembly Screw fastening on bogie frame		
	4.7.3.1	1 screw missing/broken on a single axle	Replace. If not possible, K + R1 (isolate brake)	3
	4.7.3.2	2 screws missing/broken on a single axle	Detach wagon	5
Side bearers and side bearer spring	4.8			
	4.8.1	Side bearer broken		
	4.8.1.1	– with no parts missing	K	4
	4.8.1.2	– with part(s) missing	Detach wagon	5
	4.8.2	Side bearer spring broken	Detach wagon	4
	4.8.3	Incomplete or loose side bearer fastening	K	3
Friction surface(s) of damper system	4.9			
	4.9.1	Lubricated	Detach wagon	4

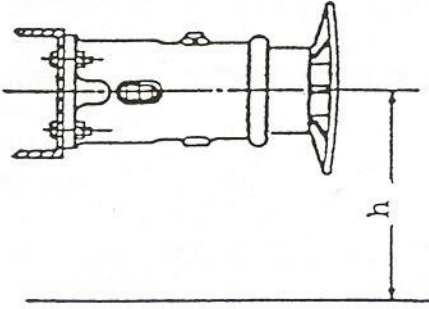
Component	Code no.	Irregularities/Criteria/Notes	Action to be taken	Irregularity class
Buffing and draw gear	5			
Buffers	5.1			
Buffer types	5.1.1	Visibly different buffer types at any wagon end <ul style="list-style-type: none"> Note buffer head⁵ 	K	4
Buffer height	5.1.2	Exceeding tolerance range <ul style="list-style-type: none"> – $h < 940$ mm (980 mm in the case of coaches) – $h > 1065$ mm • significant difference in buffer height at coupled wagon ends 	Detach wagon	5
Buffer head	5.2			
	5.2.1	Missing, broken, distorted such that it is no longer functional, rectangular plate twisted	Detach wagon	5
	5.2.2	Fastening on plunger:		
	5.2.2.1	– one third or more rivets or bolts loose	Detach wagon	4
	5.2.2.2	– fewer than one third of rivets or bolts loose	K	3

⁵ Two buffers are to be attached to each end of the wagon, each with the same spring system, buffer category, buffer head size, stroke, and housing type. Buffers that are different only with regard to the buffer head material or due to a replaced buffer head are regarded as identical. The total length of both buffers at each end of the vehicle must be equal.

Component	Code no.	Irregularities/Criteria/Notes	Action to be taken	Irregularity class
Buffer head <i>(continued)</i>	5.2.3	Surfaces in contact		
	5.2.3.1	– not lubricated, if both buffer heads are made of metal	Lubricate. If not possible, detach wagon	5
	5.2.3.2	– more than 2 sharp-edged grooves measuring > 3 mm in depth and > 50 mm in length	Detach wagon	5
	5.2.4	Buffer head insert or plastic plate		
	5.2.4.1	– broken, cracked right through, missing	Detach wagon	5
	5.2.4.2	– Crumbling/melding > 3 mm in depth and > 25 mm in length	K	4
	5.2.4.3	– Fastening: 2 or more loose/missing bolts	Detach wagon	5
Plunger	5.3			
	5.3.1	Missing, broken	Detach wagon	5
	5.3.2	Cracked at the transition to buffer head	Detach wagon	5
	5.3.3	Function jeopardised		
	5.3.3.1	Cracked longitudinally and no longer capable of guiding buffer casing	Detach wagon	5
	5.3.3.2	More than 2 grooves distributed over the circumference, each > 2 mm in depth, sharp-edged, and > 60 mm in length	Detach wagon	5
Buffer casing	5.4			
	5.4.1	Missing, broken	Detach wagon	5
	5.4.2	Cracked at transition to buffer base	Detach wagon	5
	5.4.3	Function jeopardised		
	5.4.3.1	Cracked longitudinally and no longer capable of guiding plunger	Detach wagon	5
	5.4.3.2	More than 2 grooves distributed over the circumference, each > 2 mm in depth, sharp-edged, and > 60 mm in length	Detach wagon	5

Component	Code no.	Irregularities/Criteria/Notes	Action to be taken	Irregularity class
Buffer casing <i>(continued)</i>	5.4.4	Fastening of buffer casing defective:		
	5.4.4.1	– 2 or more bolts loose <ul style="list-style-type: none"> • play between buffer casing and headstock 	Tighten bolts + M, if not possible, detach wagon	5
	5.4.4.2	– 1 bolt missing	Replace + M, if not possible, detach wagon	3
	5.4.4.3	– 1 bolt loose	Tighten + M, if not possible, K	3
Buffer spring and anti-crash components	5.5			
	5.5.1	Buffer so slack that it can be de-pressed by hand: <ul style="list-style-type: none"> – one buffer, by more than 15 mm – both buffers at the same end 	Detach wagon	4
	5.5.2	Anti-crash components triggered <ul style="list-style-type: none"> • buffer length visibly reduced • yellow marker arrow partly or completely absent⁶ • plunger damaged or deformed⁶ • indicator missing or distorted⁶ 	Detach wagon	5
	5.5.3	Anti-crash component warning mark missing or incomplete	Detach wagon	4
Screw coupler	5.6			
	5.6.1	Inoperative		
	5.6.1.1	Damaged or part missing	Rectify or use a different screw coupling + K, if not possible, detach wagon	3
	5.6.1.2	Lack of lubricant and jammed	Rectify or use a different screw coupling + K, if not possible, detach wagon	3
	5.6.2	Hook for hanging coupler damaged, inoperative or missing	M	3
	5.6.3	Coupler unhooked	Hook into position and tie up if necessary	3

⁶ Depending on buffer type

Component	Code no.	Irregularities/Criteria/Notes	Action to be taken	Irregularity class
Draw hook	5.7			
	5.7.1	Inoperative or in poor condition		
	5.7.1.1	– broken, cracked (including tip)	If possible, use the other coupling, K. If not possible, detach wagon	3
	5.7.1.2	– twisted	K	3
	5.7.2	- reserved -		
Other draw gear parts	5.8			
	5.8.1	Other draw gear parts damaged <ul style="list-style-type: none"> – length of coupler such that the buffer heads cannot be brought into contact with each other – drawbar broken, cracked or distorted – muffs, bolts, or keys broken, cracked, missing – spring inoperative <ul style="list-style-type: none"> • clearly abnormal projection of draw hook from draw hook guide 	Detach wagon	4
	5.8.2	Faulty coupling on the train	Adjust coupling	4
Long-stroke damper (e.g., on container wagons)	5.9			
	5.9.1	Sliding element not in mid-position with respect to wagon underframe <ul style="list-style-type: none"> • the two headstocks are at different distances from wagon body 	Detach wagon	5
	5.9.2	Danger marking (diagonal black bands on yellow background) missing on overlapping wagon surfaces on which the front part is liable to be displaced in relation to the underframe during impact (impact absorption devices, etc.)	Detach wagon	4

Component	Code no.	Irregularities/Criteria/Notes	Action to be taken	Irregularity class
Wagon body	6			
Wagon body in general	6.1			
Markings on wagons	6.1.1	Missing, illegible or incomplete		
	6.1.1.1	– wagon number ⁷	Detach wagon	4
	6.1.1.2	– “RIV” sign, “TEN” + “GE” or acceptance marking (“TEN” + “G1”, country acronym in approval plate) ⁷ or	Detach wagon	4
	6.1.1.3	– agreement plate (if showing exchange codes 41, 43, 45, 81, 83 or 85) ⁷ or acceptance marking (“TEN” + “CW” + country acronym in approval plate) ⁷	Detach wagon	4
	6.1.1.4	– tare weight ⁷	Detach wagon	4
	6.1.1.5	– Holding force of parking brake ⁷	Detach wagon	4
	6.1.1.6	– load limits ⁷	Detach wagon	4
	6.1.1.7	– capacity of tank wagons ⁷	Detach wagon	4
	6.1.1.8	– both the VKM and full address of wagon keeper ⁷	Detach wagon	4
	6.1.1.9	– length-over-buffers of wagon ⁷	Detach wagon	4
	6.1.1.10	– “high voltage” warning sign on wagons with step or ladder access up to a height > 2 m above rail level	Detach wagon	4
	6.1.1.11	– indication of compatibility with ILUs on carrying wagon ⁷	Detach wagon	4
	6.1.1.12	- reserved -		
	6.1.1.13	- reserved -		

⁷ If this irregularity is only found on one side of the wagon: affix K

Component	Code no.	Irregularities/Criteria/Notes	Action to be taken	Irregularity class
Overhaul	6.1.2	Overhaul marking		
	6.1.2.1	Inscription on the maintenance plate missing, incomplete or illegible ⁷	Detach wagon	4
	6.1.2.2	Maintenance plate (Possible extension of validity if wagons marked "+ 3M") Validity expires in 15 days or less	K	3
	6.1.2.3	Validity has expired ≤ 6 months	Proceed in accordance with point 1 of Annex 8	4
	6.1.2.4	Validity has expired > 6 months	Proceed in accordance with point 1 of Annex 8	4
Framework	6.1.3	Part of framework damaged		
	6.1.3.1	– without fouling the loading gauge	K	3
	6.1.3.2	– with fouling the loading gauge	Detach wagon	5
Walls	6.1.4			
	6.1.4.1	Side plank missing, broken, split or coming undone; wall panel holed, broken	K	3
	6.1.4.2	Risk of damage to load due to humidity; risk of loss of load	Rectify if necessary + K. If not possible, detach wagon	4
Floors	6.1.5	Floor damaged		
	6.1.5.1	– with no risk of loss of load	K	3
	6.1.5.2	– with risk of loss of load	Rectify if necessary + K. If not possible, detach wagon	4

⁷ If this irregularity is only found on one side of the wagon: affix K

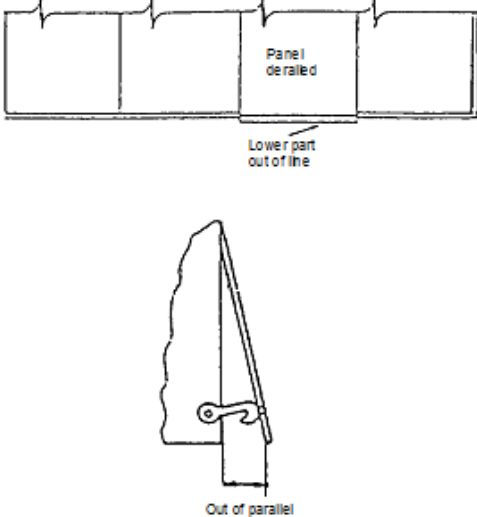
Component	Code no.	Irregularities/Criteria/Notes	Action to be taken	Irregularity class
Doors and sliding walls	6.1.6 6.1.6.1	Not fully closed or not fastened	Close and/or secure. If not possible, fasten + K. If fastening not possible, detach wagon	5
	6.1.6.2	Missing or derailed <ul style="list-style-type: none"> • abnormal position in relation to its frame 	If putting back in position is possible, fasten + K. If not possible, detach wagon	5

Component	Code no.	Irregularities/Criteria/Notes	Action to be taken	Irregularity class
		<p>guide rail</p> <p>claw slipped out of guide rail</p> <p>closing level not returned to vertical position</p> <p>panel not closed</p> <p>alignment fault</p> <p>a</p> <p>b</p> <p>a > b</p> <p>Door derailed; rollers no longer on rail</p>		

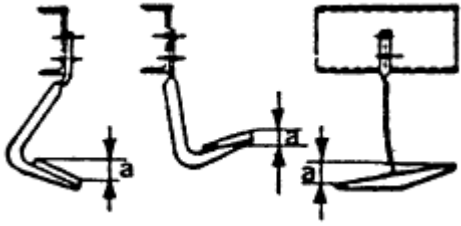
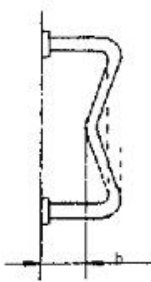
Component	Code no.	Irregularities/Criteria/Notes	Action to be taken	Irregularity class	
Doors and sliding walls <i>(continued)</i>	6.1.6.3	Guiding or locking elements in poor condition – door frame, hinges, locks, latch hooks, handles missing, broken; dislocated, deformed	Temporary repair + K. If not possible, detach wagon	3	
	6.1.6.4	– safety hazard or risk of loss of load		5	
	6.1.6.5	Doors broken or warped – no risk of fouling the gauge or losing the load	Temporary repair + K. If not possible, detach wagon	3	
	6.1.6.6	– risk of gauge being fouled or loss of load		5	
	Various parts (steps, handles, ladders, gangways, guard rails, inscription plates and others)	6.1.7			
		6.1.7.1	Ladders, gangways, guard rails in poor condition, unusable	K	4
6.1.7.2		Steps: missing	K	4	
6.1.7.3		Steps: damage representing a safety hazard for staff, torn off or deformed beyond tolerated limit (a > 80 mm) 	Detach wagon	4	
6.1.7.4		Handles: missing, damage representing a safety hazard for staff, torn off or deformed beyond tolerated limit (b < 60 mm) 	Temporary repair + M. If not possible, detach wagon	4	

Component	Code no.	Irregularities/Criteria/Notes	Action to be taken	Irregularity class
Various parts (steps, handles, ladders, gangways, guard rails, inscription plates and others) <i>(continued)</i>	6.1.7.5	Inadequate securing of – inscription plates – folding plates – label holders	Temporary repair + M. If not possible, detach wagon	4
	6.1.7.6	Missing – inscription plates – folding plates – label holders	Temporary labels + K. If not possible, detach wagon	3
	6.1.7.7	Loose wagon accessories missing or incomplete	M	3
	6.1.7.8	Loose wagon accessories not secured	Fasten	4
	6.1.7.9	Signal brackets, rope eyes missing, unfit for use	M	3
Internal fittings⁸	6.1.8	Defective internal fittings: – holding arm – guide rail – loading cradle – loops, hooks, eyelets – dividing walls	Temporary repair, rectify using additional fastenings + M. If not possible, detach wagon	3
	6.1.8.1			5
	6.1.8.2	Wagon with fastening equipment (see also no. 6.6.7), car carrying wagon, wheel scotches (see also no. 6.6.5.2)		
Covered wagons Ventilation flaps	6.2			
	6.2.1	Missing, damaged		
	6.2.1.1	– without any risk of damage due to humidity or fouling of the loading gauge	Rectify + K. If not possible, detach wagon	3
	6.2.1.2	– with risk of damage due to humidity or fouling of the gauge	Detach wagon	5

⁸ Defective internal fittings: Observed during a special inspection separate to the technical inspection

Component	Code no.	Irregularities/Criteria/Notes	Action to be taken	Irregularity class
Control gear, shutter retaining bracket	6.2.2	Unhooked, distorted, loose	Rectify + K. If not possible, detach wagon	3
	6.2.2.1	– without any risk of fouling the gauge		
	6.2.2.2	– with risk of fouling the gauge		5
Roof and weatherboard	6.2.3	Roof cover or weatherboard loose, compromising safety or water tightness	Detach wagon	4
	6.2.4	Opening roof	Close and lock roof if necessary + K. If not possible, detach wagon	5
	6.2.4.1	– not fully closed, not secured		
	6.2.4.2	– derailed	Set back in rails and secure; otherwise, detach wagon	5
	6.2.4.3	– control mechanism missing, distorted, ineffective	K	4
Open wagons Side walls or end flaps	6.3			
	6.3.1	Damaged	M	3
	6.3.1.1	– with no risk of losing the load or fouling the gauge		
	6.3.1.2	– with risk of losing load	Rectify + K. If not possible, detach wagon	4
6.3.1.3	– with risk of fouling the gauge	Rectify + K. If not possible, detach wagon	5	
Closing and operating gear of end flaps	6.3.2	Pins, camshafts, retaining hooks, shaft supports, etc. missing, broken, cracked, inoperative	Repair temporarily + K. If not possible, detach wagon	3
	6.3.2.1	– without compromising safety		
	6.3.2.2	– compromising safety		5

Component	Code no.	Irregularities/Criteria/Notes	Action to be taken	Irregularity class			
Cantrail	6.3.3	Broken or deformed	Rectify + K. If not possible, detach wagon	3			
	6.3.3.1	– with no risk of fouling the gauge					
	6.3.3.2	– with risk of fouling the gauge		5			
Flat wagons Drop sides	6.4	Folded down and not secured	Secure. If not possible, detach wagon	5			
	6.4.1						
	6.4.1.1						
	6.4.1.2				Folded but not authorised in table 3 of the Loading Guidelines	Raise. If not possible, detach wagon	5
	6.4.1.3				Distorted with no risk of losing load or fouling the gauge	M	3
	6.4.1.4				Holed or distorted with risk of losing load	Rectify + K. If not possible, detach wagon	4
6.4.1.5	Distorted with risk of fouling the gauge	Rectify + K. If not possible, detach wagon	5				
Hinges, pins, securing bolts	6.4.2	Missing, inoperative, broken	Repair temporarily + K. If not possible, detach wagon	3			
	6.4.2.1	– but not compromising safety or involving risk of loss of load					
	6.4.2.2	– compromising safety or involving risk of loss of load		4			
Stanchions - detachable - pivoting - retractable	6.4.3	Missing and necessary to secure load	If not possible to rectify, detach wagon	5			
	6.4.3.1						
	6.4.3.2	Deformed and fouling the gauge		5			
	6.4.3.3	Crack or break in stanchion or in its mounting or fixing device		If presence of stanchion is required: detach wagon; otherwise, M	4		
	6.4.3.4	Stanchion chains hanging loose		Rectify	4		
	6.4.3.5	Stanchion fastening ineffective		Fasten, K. If not possible, detach wagon	4		

Component	Code no.	Irregularities/Criteria/Notes	Action to be taken	Irregularity class
Bolsters	6.4.4 6.4.4.1	Broken, timber bearing surface or joint unfit for use	M	3
	6.4.4.2	Loose bolsters not secured by side stanchions or load	Rectify; otherwise detach wagon	4
Tank wagons Tank cradle	6.5 6.5.1 6.5.1.1	Crack extending > ¼ across the cross-section } Crack in the weld seams	If empty: K If loaded, detach wagon	4
	6.5.1.2			4
	6.5.1.3	Up to 10% of the bolts or rivets securing tank body to cradle missing	K	4
	6.5.1.4	More than 10% of the bolts or rivets securing tank body to cradle missing	Detach wagon	4
	Tank	6.5.2 6.5.2.1	Not sealed: leaks or risk of loss of load – Odours – Traces of recent or persistent leakage	Have sealed + K. For RID: to have cleaned by qualified personnel. If not possible, detach wagon
6.5.2.2		Distorted with sharp edges but no risk of loss of load	K	4
6.5.2.3		Test date expired, RID load Without “L” marking Tank full:	K	4
		– Deadline has expired ≤ 1 month		
6.5.2.4		– Deadline has expired > 1 month	Detach wagon	5
6.5.2.5		Tank empty, not cleaned:	K	4
		– Deadline has expired ≤ 1 month – or > 1 month		
6.5.2.6		With “L” marking Tank full:	Detach wagon	5
		– Deadline has expired > 3 months		
6.5.2.7	Tank empty, not cleaned: – Deadline has expired > 3 months	K	4	

Component	Code no.	Irregularities/Criteria/Notes	Action to be taken	Irregularity class
Tank equipment	6.5.3	Tank cladding, sunroof, insulation		
	6.5.3.1	– damaged	K	4
	6.5.3.2	– loose	Detach wagon	5
	6.5.4	- reserved -		
Reinforcement, filling and emptying equipment, underneath	6.5.5			
	6.5.5.1	Loss of load	Rectify. If not possible, detach wagon	5
	6.5.5.2	- reserved -		
	6.5.5.3	Valves or spouts defective	Detach wagon	4
	6.5.5.4	Screw caps must be tightly sealed and must not be missing (except for outside gas pipes) – RID load ⁹	Rectify. If not possible, detach wagon	4
	6.5.5.5	– non-RID load	Rectify. If not possible, M	3
	6.5.5.6	Blind flange missing	Detach wagon	4
	6.5.5.7	Securing bolt of the blind flange – RID load ⁹ , one or more securing bolts missing or loose	Detach wagon	4
	6.5.5.8	– non-RID load, one securing bolt missing or loose	Rectify. If not possible, K	3
	6.5.5.9	– non-RID load, several securing bolts missing or loose bottom valve indicator device not in “closed” position on both sides	Rectify. If not possible, detach wagon	4
6.5.5.10	Bottom valve indicator device not showing “closed” on both sides – loaded wagons, and empty wagons that have not been cleaned (RID load ⁹)	Close bottom valve. If not possible, detach wagon	5	

⁹ Clarification: pay attention to the hazard warning labels

Component	Code no.	Irregularities/Criteria/Notes	Action to be taken	Irregularity class
Reinforcement, filling and emptying equipment, underneath <i>(continued)</i>	6.5.5.11	– empty wagons (non-RID load)	Close bottom valve. If not possible, K	3
	6.5.5.12	Bottom valve emergency control device screwed in (tank-mounted valve open)	Detach wagon	5
	6.5.5.13	Filling and emptying equipment open	Rectify. If not possible, detach wagon	5
	6.5.5.14	Visible locking devices ineffective	Rectify. If not possible, detach wagon	4
Reinforcement, filling equipment, above	6.5.6 6.5.6.1	Loss of load or gas near the upper reinforcements (does not concern ventilation devices) <ul style="list-style-type: none"> • Odours • Signs of recent or persistent leakage 	Detach wagon	5
	6.5.6.2	Dome cover open or missing	Close or have closed. If not possible, detach wagon	5
	6.5.6.3	Other upper reinforcements not closed	Close or have closed. If not possible, detach wagon	4
	6.5.7	- reserved -		

Component	Code no.	Irregularities/Criteria/Notes	Action to be taken	Irregularity class
Reinforcement, filling equipment, above	6.5.6			
	6.5.6.1	Loss of load or gas near the upper reinforcements (does not concern ventilation devices) <ul style="list-style-type: none"> • Odours • Signs of recent or persistent leakage 	Detach wagon	5
	6.5.6.2	Dome cover open or missing	Close or have closed. If not possible, detach wagon	5
	6.5.6.3	Other upper reinforcements not closed	Close or have closed. If not possible, detach wagon	4
	6.5.7	- reserved -		

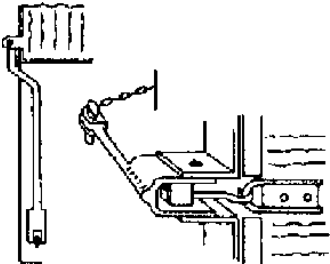
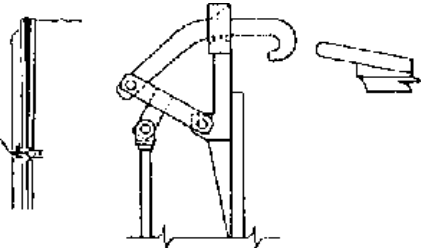
Component	Code no.	Irregularities/Criteria/Notes	Action to be taken	Irregularity class
<p>Wagons with special fittings</p> <p>Wagons with mechanical sheeting (e.g., Rils, Tams)</p>	6.6			
	6.6.1			
	6.6.1.1	<p>Mechanical sheeting not properly closed and locked</p> <ul style="list-style-type: none"> indicator visible → side closing system open <p style="text-align: center;">Side locking system</p>  <ul style="list-style-type: none"> end hoops inclined → locking system not engaged <p style="text-align: center;">Top locking system</p> 	Close. If not possible, detach wagon	5
	6.6.1.2	Tarpaulin – tarpaulin torn, holed ≤ 30 mm	Rectify	3
	6.6.1.3	Tarpaulin – tarpaulin torn, holed > 30 mm	Detach wagon	5
6.6.1.4	Tarpaulin – eyelet missing, torn off	Rectify + K. If not possible, detach wagon	4	

Component	Code no.	Irregularities/Criteria/Notes	Action to be taken	Irregularity class
Wagons with telescopic hood (e.g. Shimms)	6.6.2 6.6.2.1	Hood not locked 	Lock. If not possible, make secure+ K; otherwise detach wagon	5
	6.6.2.2	External hood off the rail	Detach wagon	5
Flat bogie wagons for transport of road vehicles (e.g., Saad)	6.6.3 6.6.3.1	Moveable headstocks damaged	K	4
	6.6.3.2	Moveable headstocks not locked into place on both sides	Lock. If not possible, detach wagon	5
	6.6.3.3	Seating device, seating device bolt, securing chains or chain eyelets not working	Rectify. If not possible, detach wagon	4
	6.6.3.4	Wheel scotches damaged	M	3
ACTS ^{*)} carrier wagons with swivel frame <small>^{*)} Roll on/off container transport system</small>	6.6.4 6.6.4.1	Swivel frame damaged	K	4
	6.6.4.2	Locking device preventing the frame from swiveling ineffective or unlocked – locking lever not secured or locked in position ¹⁰ – stanchions not in position and not secured ¹⁰ – snap lock (safety bolt) defective and handle in unlocked position ¹⁰	Secure and lock. If not possible, detach wagon	5
	6.6.4.3	Pneumatic monitoring system on the swivel lock not in service and not labelled	Put in service	4

¹⁰ Rules for the use of the swivel frame system to be complied with

Component	Code no.	Irregularities/Criteria/Notes	Action to be taken	Irregularity class
ACTS *) carrier wagons with swivel frame *) Roll on/off container transport system (continued)	6.6.4.4	Pneumatic monitoring system on the swivel lock triggered	Check swivel lock. If no fault found, disconnect monitoring system + K	3
	6.6.4.5	Device to prevent container lifting ineffective – locking lever not secured or locked in position ¹⁰	Secure. If not possible, detach wagon	5
	6.6.4.6	Device to prevent containers moving ineffective ¹⁰	Detach wagon	5
Car-carrying wagons	6.6.5			
	6.6.5.1	Damage to lifting and lowering equipment, crossing gangways and footplates	K	4
	6.6.5.2	Damage to wheel scotch, wheel guides or crank handle	M	3
	6.6.5.3	End boards and crossing gangways – where required – not raised and secured	Rectify. If not possible, detach wagon	4
	6.6.5.4	Upper loading deck, indicator device not engaged	Secure	4
	6.6.5.5	Upper loading deck not secured	Secure. If not possible, detach wagon	5
	6.6.5.6	Upper loading deck not resting on supporting bracket (suspended by cables)	Rectify. If not possible, detach wagon	5
6.6.5.7	Upper deck loaded but fouling the gauge	Detach wagon	5	

¹⁰ Rules for the use of the swivel frame system to be complied with

Component	Code no.	Irregularities/Criteria/Notes	Action to be taken	Irregularity class
Car-carrying wagons (continued)	6.6.5.8	Gangways above central axles not fully maneuverable on loaded wagons <ul style="list-style-type: none"> distance: ≤ 100 mm between wheel of vehicle and gangway 	Rectify. If not possible, detach wagon	5
	6.6.5.9	Mechanical damage to support and fastening of crossover plates on central axles <ul style="list-style-type: none"> distorted, breakage, cracking, missing parts – empty wagon	K	4
	6.6.5.10	– loaded wagon	Detach wagon	5
Self-discharging wagons (e.g., Tads, Fals, Tals, ...)	6.6.6	Discharge valve not closed and/or not locked		
	6.6.6.1	– empty wagon with axial flap	Close and lock. If not possible, K	3
	6.6.6.2	– loaded wagon with axial flap	Close and lock. If not possible, detach wagon	4
	6.6.6.3	– empty wagon with lateral flap	Close and lock. If not possible, detach wagon	4
	6.6.6.4	– loaded wagon with lateral flap	Close and lock. If not possible, detach wagon	4
Wagons with securing equipment (e.g., Snps, Roos, Ealos)	6.6.7			
	6.6.7.1	Unused securing equipment not properly or adequately fixed, stowed or secured	Rectify. If not possible, make safe + K	4

Component	Code no.	Irregularities/Criteria/Notes	Action to be taken	Irregularity class
Gear for securing load units (ILU) on carrier wagons	6.7			
	6.7.1	Seating device or spigot distorted or defective		
	6.7.1.1	– seating device not in use	K	3
	6.7.1.2	– seating device in use	Rectify +K. If not possible, detach wagon	5
	6.7.1.3	– spigot not in use	K	3
	6.7.1.4	– spigot in use	Rectify +K. If not possible, detach wagon	5
	6.7.2	Coupling pin of trailer not locked into trestle	Lock. If not possible, detach wagon	5
	6.7.3	Seating device not in use and not locked	Place seating device in its end position and lock. If not possible, secure temporarily + K	3
	6.7.4	Seating adjustment device unlocked and potentially fouling the gauge	Push in and secure seating adjustment device. If not possible, detach wagon	5
	6.7.5	Moving parts not properly secured (e.g., retractable spigots, handrails for shunters, etc.)		
	6.7.5.1	– no risk of fouling the gauge	Rectify. If not possible, secure provisionally	3
	6.7.5.2	– Risk of fouling the gauge	Rectify. If not possible, detach wagon	5
	6.7.6	Anti-crash system of seating device triggered, damaged elements		
	6.7.6.1	– in use	Detach wagon	5
6.7.6.2	– not in use	K, close emergency stop cock	4	

Component	Code no.	Irregularities/Criteria/Notes	Action to be taken	Irregularity class
Loads and intermodal loading units (ILU)	7			
Load in general Distribution of the load (wagon)	7.1			
	7.1.1	Load visibly displaced <ul style="list-style-type: none"> • lashing cords broken • load not positioned properly on blocks • not centrally positioned 	Detach wagon	5
	7.1.2	Load unevenly distributed (3.3), body not horizontal <ul style="list-style-type: none"> • different buffer heights (3.5) • unequal suspension spring play (3.5) 	Detach wagon, proceed as per Annex 8, point 3	5
Packing, load fastening	7.1.3	Packages, bundles, bales, stacks coming apart or not properly tied together (1.5)	Detach wagon	4
	7.1.4	Inadequate binding of narrow, cylindrical objects (1.5)	Detach wagon	4
Maximum permissible dimensions of load	7.1.5			
	7.1.5.1	Unauthorised fouling of the gauge (4.1)	Detach wagon	5
	7.1.5.2	Fouling of the gauge not indicated <ul style="list-style-type: none"> • U label missing 	Detach wagon	5
Reserved spaces	7.1.6	Encroachment of reserved spaces <ul style="list-style-type: none"> • load projecting beyond the head-stock (4.2) 	Detach wagon	5
Load limits	7.1.7			
	7.1.7.1	Exceeding of load limits (3.2), visually detected: <ul style="list-style-type: none"> • different buffer heights insufficient distance between spring buckle and solebar	Detach wagon. Proceed as per point 2 of Annex 8	5
	7.1.7.2	Exceeding of load limits (3.2), detection by: <ul style="list-style-type: none"> – discrepancy between consignment data and load limit marked on wagon measuring or diagnostic devices	Detach wagon. Proceed as per point 2 of Annex 8	5

Component	Code no.	Irregularities/Criteria/Notes	Action to be taken	Irregularity class
Buffer wagons	7.1.8	Vertical and horizontal clearances not respected between loads or between buffer wagon and load (4.3)	Detach wagon	5
Sheeting, nets	7.1.9	Inadequate, defective or secured with non-compliant fastening equipment (6.1, 6.2)	Rectify. If not possible, detach wagon	4
Loss of load	7.1.10	Loss of load (except tank wagons/tank containers), excluding other restrictions (See also codes 6.1.4.2, 6.1.5.2, 6.1.6.4, 6.1.6.6, 6.3.1.2, 6.4.1.4, 6.4.2.2 and 7.5.5.3)	Rectify. If not possible, detach wagon	5
Load securing equipment	7.2			
Wagon walls or sides	7.2.1	Load projecting beyond the walls and sides and inadequately secured (5.4.1)	Detach wagon	5
	7.2.2	Load clearly pressing against walls, sides or doors and thus hindering their functioning, with risk of damage or operating hazard (2.3)	Detach wagon	4
Stanchions	7.2.3			
	7.2.3.1	Load inadequately secured by stanchions (2.5 and 5.4.1)	Detach wagon	5
	7.2.3.2	Fastenings between opposite stanchions missing (2.5)	Detach wagon	5
	7.2.3.3	Load pressing up against and bending stanchions (2.5)	Detach wagon	5
	7.2.3.4	Load which is heavy and/or which may damage side stanchions in the event of longitudinal displacement, pressing up against stanchions (2.5)	Detach wagon	4

Component	Code no.	Irregularities/Criteria/Notes	Action to be taken	Irregularity class
Scotches fastened with nails	7.2.4	Non-compliant (5.4.3) – insufficient – ineffective – incorrectly fastened on the floor	Detach wagon	5
Direct or indirect fastenings (lashing)	7.2.5	Non-compliant (5.4.4, 5.5.4)		
	7.2.5.1	– unsuitable or unauthorised material	Detach wagon	5
	7.2.5.2	– incorrectly or inadequately fastened	Rectify. If not possible, detach wagon	5
	7.2.5.3	– slack	Rectify. If not possible, detach wagon	4
Bolsters, timbers, stretchers, fastening gear	7.2.6			
	7.2.6.1	Non-compliant (5.5.5, 5.6.2, 5.8.1) – damaged – poorly chosen – inadequate – incorrectly arranged – loose	Detach wagon	5
	7.2.6.2	Auxiliary loading equipment or fastening gear not removed	Rectify	3
Load residues	7.2.7	Load residues which may compromise safety not removed	Remove. If not possible, detach wagon	5
Loading and load securing methods	7.3			
	General	7.3.1	Load unstable and wrongly secured (5.1)	Detach wagon
Goods subject to lifting by airflow (e.g., light scrap, thin boards, bulk goods)	7.3.2	Covering missing or inadequate (5.2.1, 5.3.2)	Detach wagon	5

Component	Code no.	Irregularities/Criteria/Notes	Action to be taken	Irregularity class
Goods which may fall off on account of vehicle vibrations and impacts (wire metal trellis-work, metal filings etc.)	7.3.3	Insufficient clearance between goods and top edge of walls of the wagon (5.2.2) <ul style="list-style-type: none"> load protruding beyond top edges of walls 	Detach wagon	5
	7.3.3.1			
	7.3.3.2	Dome-shaped load too high (5.3.1)	Detach wagon	5
Stacked goods	7.3.4	Wrongly stacked (5.8) <ul style="list-style-type: none"> uneven distribution over floor too high poorly stacked inadequate bindings insufficient clearance between a load liable to sway and loading gauge cylindrical loads inadequately secured 	Detach wagon	5
Load with inadequate supporting area, liable to damage the wagon floor	7.3.5	Scotches missing or insufficient (2.2) <ul style="list-style-type: none"> floor damaged 	K	3
	7.3.5.1			
Concentrated load on flat wagon	7.3.5.2	Excessive concentration of load (3.4) <ul style="list-style-type: none"> scotches in place, unsuitable material used scotches in place, dimensions insufficient pronounced deflection of wagon underframe	Detach wagon, proceed as per Annex 8, point 3	5
Load liable to tip	7.3.6	Not secured against overturning (5.7)	Detach wagon	5
Tilted load	7.3.7	Insufficiently supported (5.7)	Detach wagon	5
Load liable to roll	7.3.8	Inadequately secured against rolling (5.6.1, 5.6.2)	Detach wagon	5

Component	Code no.	Irregularities/Criteria/Notes	Action to be taken	Irregularity class
Load liable to slide lengthways	7.3.9			
	7.3.9.1	Laid on unsuitable – timbers – guide blocks – skids	Detach wagon	4
	7.3.9.2	Lateral guide-pieces missing or insufficient with risk of fouling the gauge or exceeding load limit (5.5)	Detach wagon	5
	7.3.9.3	Necessary clearances missing (5.5.2)	Detach wagon	3
	7.3.9.4	Necessary scope for sliding not limited (5.5.3)	Detach wagon	4
Special types of consignment Vehicles and machinery on wheels or caterpillar tracks/chains	7.4			
	7.4.1	Unsuitable scotch blocks and/or fastenings (5.6.3)	Rectify. If not possible, detach wagon	5
Moving parts of vehicles and machinery	7.4.2	Not properly immobilised		
	7.4.2.1	– no risk of fouling the gauge	Rectify. If not possible, detach wagon	3
	7.4.2.2	– risk of fouling the gauge	Detach wagon	5
Load supported on several wagons	7.4.3	Not loaded/secured according to requirements (5.9)	Detach wagon	5
Specific components of ILU, in particular those used for horizontal or vertical transshipment	7.5			
	7.5.1	Device for locking the dollies inoperative, defective or missing	Bind using wire. If not possible, detach wagon	4
	7.5.2	End doors on load units not securely closed or not properly locked		
	7.5.2.1	– door not closed	Close and lock. If not possible, detach wagon	5
	7.5.2.2	– Door not properly locked (not applicable to doors facing another load unit) if: <ul style="list-style-type: none"> • Upper cam not engaged or • Lower cam not engaged or • Horizontal locking lever not engaged 	Rectify, if not possible, detach wagon	4

Component	Code no.	Irregularities/Criteria/Notes	Action to be taken	Irregularity class
Specific components of ILU, in particular those used for horizontal or vertical transshipment (continued)	7.5.2.3	- reserved -		
	7.5.3	Lower corner casting damaged	Detach wagon	5
	7.5.4	Side wall, lining damaged, inadequately secured, unstable <ul style="list-style-type: none"> • hinges, securing bolts damaged, broken, missing • edge plank missing, broken, cracked or split; lining holed or broken 	Detach wagon	5
	7.5.5	Tarpaulin		
	7.5.5.1	– tarpaulin torn, holed ≤ 30 mm	Rectify	3
	7.5.5.2	– tarpaulin torn, holed > 30 mm	Detach wagon	5
	7.5.5.3	Danger of damage from humidity to the load or loss of load	Rectify, if not possible, detach wagon	4
	7.5.6	Tarpaulin, walls <ul style="list-style-type: none"> – locking, lashings inadequate – sheet; lack of tension/lock damages, inadequate 	Detach wagon	5
	7.5.7	Frame/load-bearing parts <ul style="list-style-type: none"> – cracked – broken 	Detach wagon	5
ILU tank Element connecting tank body and underframe	7.6			
	7.6.1			
	7.6.1.1	Crack > ¼ of the cross-section	Detach wagon	4
	7.6.1.2	Cracks in the weld seams	Detach wagon	4
Tank¹¹	7.6.2	Not tight: leaks or loss of load <ul style="list-style-type: none"> – Odours – Traces of recent or persistent leakage 	Have sealed. For RID: to have cleaned by qualified personnel. If not possible, detach wagon	5
	7.6.2.1			
	7.6.2.2	Distorted with sharp edges but no risk of loss of load	Rectify	4

¹¹ Clarification: moreover, verify 7. 8

Component	Code no.	Irregularities/Criteria/Notes	Action to be taken	Irregularity class
Tank equipment	7.6.3	Tank cladding, sunroof, insulation		
	7.6.3.1	– damaged	Rectify	4
	7.6.3.2	– loose	Detach wagon	5
Reinforcement, filling and emptying equipment, underneath	7.6.4			
	7.6.4.1	Loss of load	Rectify, if not possible, detach wagon	5
	7.6.4.2	Valves or spouts defective	Detach wagon	4
	7.6.4.3	Screw cap must be tightly sealed and not missing – RID load ¹²	Rectify. If not possible, detach wagon	4
	7.6.4.4	– non-RID load	Rectify. If not possible, detach wagon	3
	7.6.4.5	Blind flange missing	Detach wagon	4
	7.6.4.6	Securing bolt of the blind flange – RID load ¹² , one or more securing bolts missing or loose	Detach wagon	4
	7.6.4.7	– non-RID load, one securing bolt missing or loose	Rectify. If not possible, detach wagon	3
	7.6.4.8	– non-RID load, several securing bolts missing or loose	Rectify. If not possible, detach wagon	4
Reinforcement, filling and emptying equipment, underneath (continued)	7.6.4.9	Bottom valve indicator device not in “closed” position on both sides – loaded load units, and empty wagons that have not been cleaned (RID load ¹²)	Close bottom valve. If not possible, detach wagon	5
	7.6.4.10	– empty load unit (non-RID load)	Close bottom valve. If not possible, detach wagon	3
	7.6.4.11	Bottom valve emergency control device screwed in (tank-mounted valve open)	Detach wagon	5
	7.6.4.12	Filling and emptying equipment open	Rectify. If not possible, detach wagon	5

¹¹ Clarification: pay attention to the hazard warning labels

Component	Code no.	Irregularities/Criteria/Notes	Action to be taken	Irregularity class
Reinforcement, filling and emptying equipment, underneath <i>(continued)</i>	7.6.4.13	Non-efficient visible locking devices	Rectify. If not possible, detach wagon	4
Reinforcement, filling and emptying equipment, above	7.6.5 7.6.5.1	Loss of load or of gas near the upper reinforcements (does not concern ventilation devices) <ul style="list-style-type: none"> • Odours • Signs of recent or persistent leakage 	Detach wagon	5
	7.6.5.2	Dome cover open or missing	Close or have closed. If not possible, detach wagon	5
	7.6.5.3	Other upper reinforcements not closed	Close or have closed. If not possible, detach wagon	4
Loading of ILU	7.7			
	7.7.1	ILU too heavy for wagon	Detach wagon	5
	7.7.2	Corner castings not engaged on their respective spigots	Detach wagon	5
	7.7.3	Spigots of hinged support plates neither raised nor secured	Raise and secure. If not possible, detach wagon	5
Loading of ILU <i>(continued)</i>	7.7.4	Air suspension system of semi-trailer not emptied	Empty. If not possible, detach wagon	5
	7.7.5	Underrun bumpers of semi-trailer: not raised/pushed in, even in the absence of contact with carrier wagon <ul style="list-style-type: none"> – on recess wagons without compatibility codes – on recess wagons marked with one of the following compatibility codes: a, b, c or d 	Rectify (raise/push in and lock)	3
	7.7.6	Semi-trailer with P coding: contact between semi-trailer and wagon (other than wheels and trestle)	Rectify. If not possible, detach wagon	4

Component	Code no.	Irregularities/Criteria/Notes	Action to be taken	Irregularity class
Loading of ILU <i>(continued)</i>	7.7.7	Semi-trailer with N coding loaded on carrier wagon with wagon compatibility code N (Novatrans system): contact between parts of the semi-trailer and wagon (other than the wheels, skids and longitudinal members in the intended support areas)	Rectify. If not possible, detach wagon	4
	7.7.8	Incorrect scotching of wheels of semi-trailer	Rectify. If not possible, detach wagon	4
	7.7.9	Load displaced in the ILU <ul style="list-style-type: none"> deformation of sheeting 	Detach wagon	5
Marking, coding for intermodal transport	7.8			
	7.8.1	Valid coding missing or illegible	Detach wagon	5
	7.8.2	ILU incompatible with carrying wagon	Detach wagon	5
	7.8.3	Absence of CSC safety plate <ul style="list-style-type: none"> on ILUs with upper corner castings 	Detach wagon	4
	7.8.4	Missing warning sign "danger: high voltage" <ul style="list-style-type: none"> on ILUs with steps 	Detach wagon	4
Particular incidents	8			
Operating irregularities	8.1			
	8.1.1	Derailment	Detach, proceed following Annex 9, I+K	5
	8.1.2	Abnormal buffering impact	Detach, proceed following Annex 9, I+K	5
Other events	8.2			
	8.2.1	Flood and weather damage	Detach	5
	8.2.2	Damage from priming current <ul style="list-style-type: none"> wagon was in contact with catenary under high voltage 	Detach	5
	8.2.3	Fire	Detach	5

APPENDIX 9, ANNEX 2

Irregularity Classes

Class	Definition	Value
1	Insignificant irregularities having no effect on a wagon's fitness to run or on operating safety Not considered in the QMS system	0.002
2	Irregularities having small effect on a wagon's fitness to run Not considered in the QMS system	0.050
3	Minor irregularities Irregularities having a considerable effect on a wagon's fitness to run and irregularities having an impact on operations (missing or wrong markings)	0.125
4	Major irregularities Irregularities which render a wagon unfit to run or which jeopardise operations and irregularities which might result in injuries (freight train crews)	0.400
5	Critical irregularities Irregularities with serious consequences for operating safety and irregularities presenting an immediate risk to transport operations	1.000

-reserved-

APPENDIX 9, ANNEX 3

Size of samples as per ISO 2859 – Part I

Excerpt from Table 1: Code letters indicating size of samples

Batch size			General inspection level		
			I	II	III
2	to	8	A	A	B
9	to	15	A	B	C
16	to	25	B	C	D
26	to	50	C	D	E
51	to	90	C	E	F
91	to	150	D	F	G
151	to	280	E	G	H
281	to	500	F	H	J
501	to	1200	G	J	K
1201	to	3200	H	K	L
3201	to	10000	J	L	M
10001	to	35000	K	M	N
35001	to	150000	L	N	P
150001	to	500000	M	P	Q
500001	and	above	N	Q	R

Excerpt from Table 2-A: Simple sampling guidelines for standard inspections

Code letter for the sample size	AQL	1	2.5
	Sample size	Acceptance value for	
		Class 5	Class 4
A	2	0	0
B	3	0	0
C	5	0	0
D	8	0	0
E	13	0	1
F	20	0	1
G	32	1	2
H	50	1	3
J	80	2	5
K	125	3	7
L	200	5	10
M	315	7	14
N	500	-	-
P	800	-	-
Q	1250	-	-
R	2000	-	-

Overview I: Procedure for the inclusion of a train in an agreement

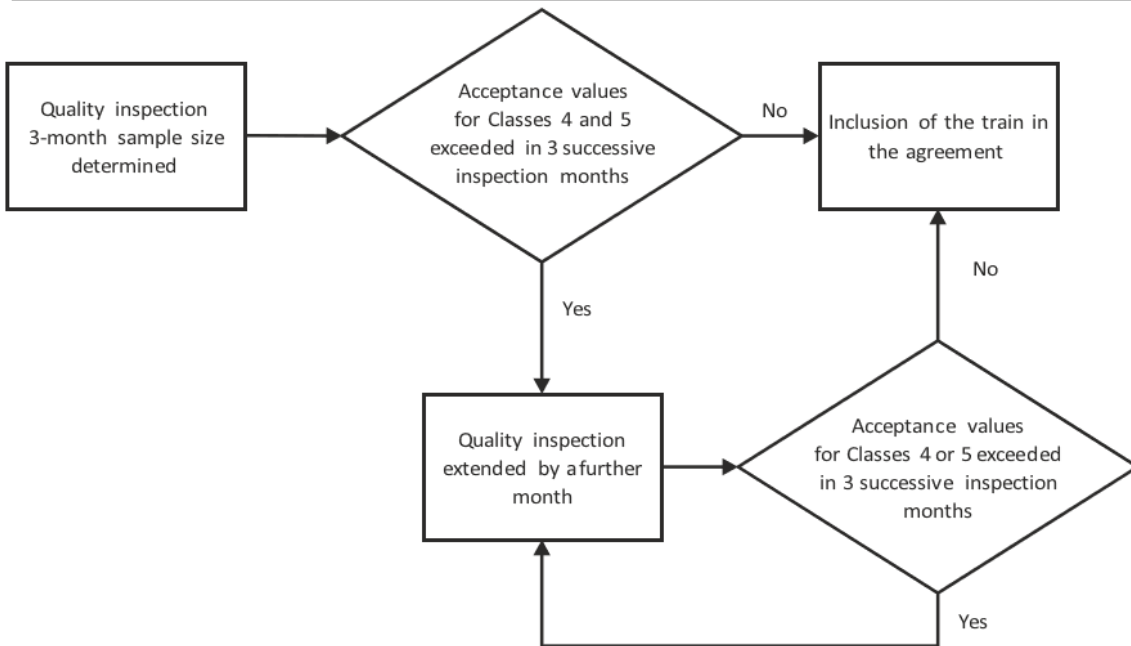

Overview II: Procedure for the exclusion of trains from an agreement

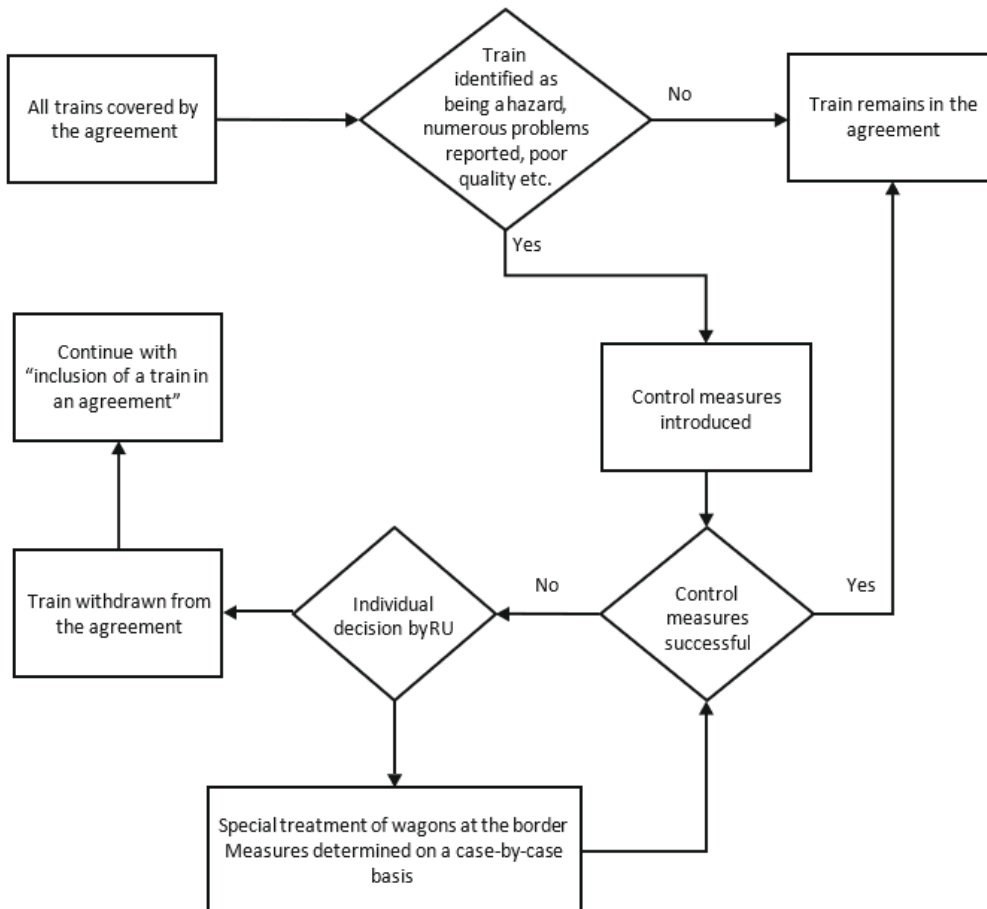

**Record of the inclusion of trains in an agreement
Route between RU 1 – RU 2 – RU 3 – RU 4 and back, 2007**

Train	Train run

Average number of wagons	
Days of operation per week	

RU carrying out the technical inspection	
Place where technical inspection is carried out	

Scheduled number of inspections (3 months)	
Scheduled number of inspections per month	

RU carrying out the quality inspection	
--	--

Max. acceptance value for Class 4 over 3 months	
Max. acceptance value for Class 5 over 3 months	

Number	January	February	March	April	May	June	July	August	September	October	November	December
Actual number of wagons inspected												
Class 4												
Class 5												
Comments												

Inclusion of the train in the agreement approved by

RU 1
Date, signature

RU 2
Date, signature

RU 3
Date, signature

RU 4
Date, signature

Record of the inclusion of trains in an agreement

APPENDIX 9, ANNEX 4

Verification of qR

Measured at the wheel flange using a gauge, qR must always be greater than 6.5 mm, with no sharp edges or burrs on the outer part of the flange over a distance of 2 mm from the top of the flange.

Fig. 1 - Permissible profile for outer part of flange

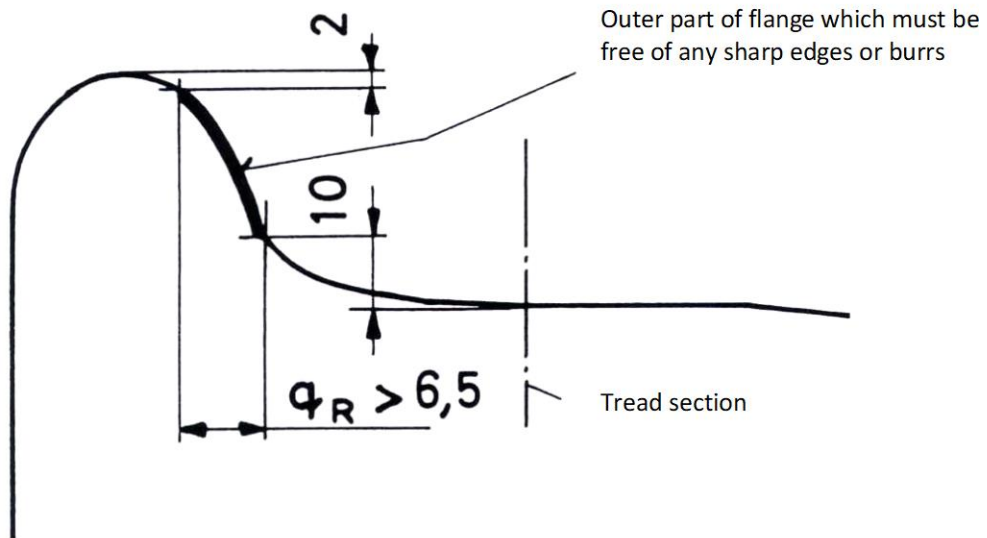

Fig. 2 - Gauge for verifying qR

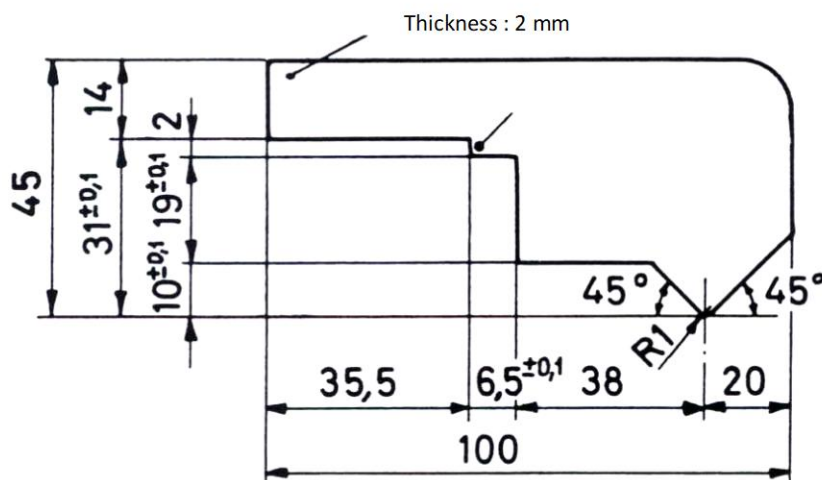

Fig. 3

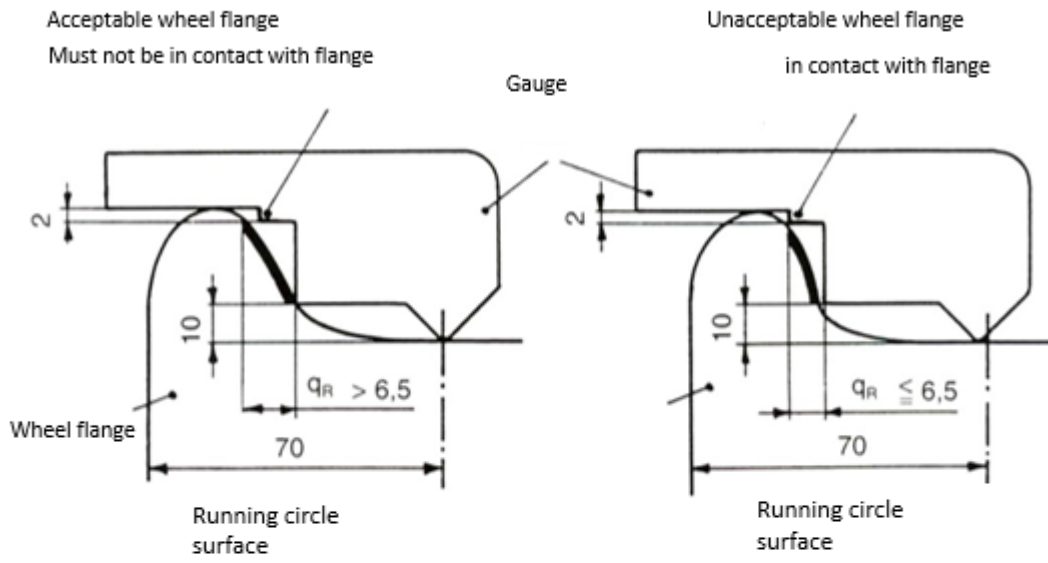
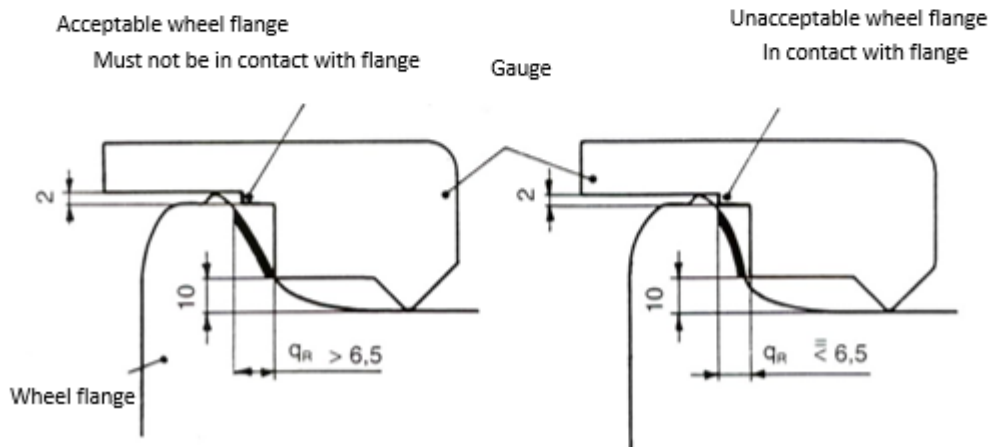

Fig. 4

Wheel flange with sharp edges or burr formation



APPENDIX 9, ANNEX 5

Catalogue of inspections in accordance with Annex 1

Code no.	Wagon	Component	Quality requirement	Control criteria ¹	Irregularity class
1.1.1	All wagons	Thickness of tyre	Compliance with dimensions set	VC, M	4
1.1.2		Tyre	Neither broken nor cracked	VC, HT	5
1.1.3		Tyre	Tight, not turned, clear ring, rust $\leq 1/3$ of circumference	VC, HT	5
1.1.4		Tyred wheel	Control marks present	VC	4
1.1.5		Tyre	Tight, not displaced laterally	VC, HT	5
1.1.6		Tyre clip	Present, not cracked, not broken	VC	5
1.2.1	All wagons	Tyre (solid wheel)	Groove marking minimum thickness fully visible in cross- section	VC	4
1.2.2.1		Tyre (solid wheel), except wheels marked as able to withstand high thermal stresses	No thermal overload due to braking, tolerance range not exceeded	VC, M	4
1.2.2.2.		Tyre (solid wheel), except wheels marked as able to withstand high thermal stresses	No thermal overload due to braking, tolerance range not exceeded	VC, M	5
1.3.1.1	All wagons	Tyre: width B > 139 mm and ≤ 140 mm	Compliance with stipulated tyre width	VC, M	3
1.3.1.2		Tyre: width B > 140 mm, < 133 mm Presence of a protrusion S	Compliance with stipulated tyre width	VC, M	4
1.3.2		Wheel tread	No crushing of wheel tread, no uneven contact surfaces or irregular burrs on the wheel rim	VC	4
1.3.3.1		Wheel tread	Wheel $\varnothing > 840$ mm, no wheel flat > 60 mm long	VC, M	4
1.3.3.2		Wheel tread	Wheel \varnothing : 630 mm < d ≤ 840 mm, no wheel flat > 40 mm long	VC, M	4
1.3.3.3		Wheel tread	Wheel $\varnothing \leq 630$ mm, no wheel flat > 35 mm long	VC, M	4
1.3.4.1		Wheel tread	Wheel $\varnothing > 840$ mm, no build-up of metal > 60 mm long or > 1mm thick	VC, M	4
1.3.4.2		Wheel tread	Wheel $\varnothing > 840$ mm, no build-up of metal > 10 mm ≤ 60 mm long and < 1mm thick	VC, M	3
1.3.4.3		Wheel tread	Wheel \varnothing : 630 mm < d ≤ 840 mm, no build-up of metal > 40 mm long or ≥ 1 mm thick	VC, M	4
1.3.4.4		Wheel tread	Wheel \varnothing : 630 mm < d ≤ 840 mm, no build-up of metal > 10 mm long and < 1mm thick	VC, M	3
1.3.4.5		Wheel tread	Wheel $\varnothing \leq 630$ mm, no build-up of metal > 35 mm long or ≥ 1 mm thick	VC, M	4
1.3.4.6		Wheel tread	Wheel $\varnothing \leq 630$ mm, no build-up of metal > 10 mm ≤ 35 mm long and < 1mm thick	VC, M	3

¹ VC = visual check; M = measurement; HT = hammer test; OP = operate; PM = pull or move the components

Code no.	Wagon	Component	Quality requirement	Control criteria ¹	Irregularity class
1.3.5.1		Wheel tread	Wheel $\varnothing > 840$ mm, no cavity, shelling or flaking > 60 mm long	VC, M	4
1.3.5.2		Wheel tread	Wheel \varnothing : $630 \text{ mm} < d \leq 840\text{mm}$, no cavity, shelling or flaking > 40 mm long	VC, M	4
1.3.5.3		Wheel tread	Wheel \varnothing : ≤ 630 mm, no cavity, shelling or flaking > 35 mm long	VC, M	4
1.3.6.1		Wheel tread	No cracks at the interface between the wheel tread and the front edge	VC	5
1.3.6.2		Wheelset front face, rim and inner tyre rim	No sharp-angled notches on the front face (rim or inner tyre rim) except for markings applied by the manufacturer	VC	4
1.3.6.3		Wheel tread	No damage, no notches	VC	4
1.3.6.4		Wheel tread	No damage, no notches	VC	5
1.3.7		Wheelset front faces	No lubricants or paint, except the 4 control marks	VC	5
1.3.8.1		Wheel tread	No damage	VC	4
1.3.8.2		Wheel tread	No damage, no grooves with sharp edges ≥ 1 mm deep	VC	5
1.3.8.3		Wheel tread	No damage, no furrows and false flanges > 2 mm deep	VC, M	5
1.4.1	All wagons	Flange	Compliance with height Sh	VC, M	4
1.4.2		Flange	Compliance with flange thickness, no worn flange	VC, M	5
1.4.3		Flange	Dimension qR adhered to, no sharp flange	VC, M	5
1.4.4		Flange	No burrs or sharp edges on guide face at a distance $h > 2$ mm from highest point of flange	VC, M	5
1.5.1	All wagons	Wheel centre	Not cracked, no defects repaired by welding	VC	5
1.5.2		Wheel centre	No break or crack in wheel centre, tyre clip, tyre, no defects repaired by welding	VC	5
1.6.1	All wagons	Axle	No damage; no grooving > 1 mm deep, no sharp edges	VC,	5
1.6.2	All wagons	Axle	No damage	VC	4
1.6.3	All wagons	Axle	No part rubbing against axle Check also 1.6.1 and 1.6.2	VC	4
1.7.1	All wagons	Wheel	No lateral displacement on axle; compliant value of "E"	VC, M	5

¹ VC = visual check; M = measurement; HT = hammer test; OP = operate; PM = pull or move the components

Code no.	Wagon	Component	Quality requirement	Control criteria ¹	Irregularity class
1.7.2		Wheel or immediate vicinity	No more than one of the following criteria on or near a wheel:	VC	4
			Brake triangle pin sheared off		
			Brake safety stirrup broken (see also 3.1.2)		
			Shiny traces on brake triangle end washer		
			Shiny traces on the inner spring (load spring) (see also 2.5)		
			Lifting safety catch (T) missing or loose (see also 2.5.5)		
			On Y25 bogies: hard manganese wear plate on axle boxes or guides missing or welded joints loose (see also 4.4.2)		
			See also 1.3.2		
1.8.1.1	All wagons	Axle box housing	Watertight housing	VC	4
1.8.1.2			No grease or all discharge on the wheel centre	VC	4
1.8.1.3			No trace of grease or all on the housing at the level of the cover	VC	4
1.8.2		Axle box housing	Not twisted, undamaged, guidance assured	VC	5
1.8.3.1		Axle box	No hot boxes	VC, check by hand	5
1.8.3.2		Axle box	No overheating during transport	VC	5
1.8.4	All wagons with Y bogie or derivative designs	Hard manganese wear plate	Secured, present	VC	4
2.1.1	All wagons	Spring leaves	Displacement < 10 mm with respect to the buckle	VC, M	4
2.1.2		Spring leaves	Main leaf not broken nor visibly cracked	VC	5
2.1.3		Spring leaves	No missing part	VC	4
2.1.4.1		Spring leaves	No crack on any other leaf < 1/4 of length of leaf from buckle centre	VC, M	4
2.1.4.2		Spring leaves	Intact	VC, M	3
2.1.5		Leaf spring	Sufficient spring clearance ≥ 15 mm; no recent traces of contact	VC, M	5
2.1.6		Buckle (leaf spring)	Intact, tight; key present and effective	VC	5

¹ VC = visual check; M = measurement; HT = hammer test; OP = operate; PM = pull or move the components

Code no.	Wagon	Component	Quality requirement	Control criteria ¹	Irregularity class
2.2.1.1	All wagons	Parabolic spring	No visible fracture or crack	VC	5
2.2.1.2		Parabolic spring	No breakage in buckle (no leaves touching for over 50% of their length)	VC	5
2.2.2.1		Parabolic spring	No longitudinal slippage of leaves in excess of 10 mm	VC, M	4
2.2.2.2		Parabolic spring	No longitudinal displacement of leaves	VC	3
2.2.3		Buckle (parabolic spring)	Intact, tight; key effective	VC	5
2.3.1	All wagons	Helical spring	Unbroken	VC	5
2.4.1	All wagons	Buckle boss	In position in its housing	VC	5
2.4.2		Shackle, link	Present and not displaced, damaged or out of position	VC	5
2.4.3		Link pin	Present and secured, not displaced	VC	5
2.4.4		Suspension links	Neither worn nor too long	VC	4
2.5.1	All wagons	Helical spring: main spring, tare spring	Not broken	VC	5
2.5.2.1	Empty wagons	Helical spring: auxiliary spring, load spring	In position, unbroken	VC	3
2.5.2.2	Loaded wagons	Helical spring: auxiliary spring, load spring	In position, unbroken	VC	5
2.5.3.1	All wagons	Damper rings per bogie	No rings missing, broken, damaged or unfit for use	VC	3
2.5.3.2		Damper rings per bogie	No more than one ring missing, broken, damaged or unfit for use	VC	5
2.5.4.1	All wagons	One spring cap per bogie	No cap exhibiting signs of contact or actually in contact with bogie frame	VC	3
2.5.4.2		Spring cap	Not more than one cap exhibiting signs of contact or actually in contact with bogie frame	VC	5
2.5.5	All wagons	Lifting T (safety catch)	Present and secured	VC	3
2.5.6		Suspension	No recent signs of bottoming	VC	5
3.1.1	All wagons	Brake rigging	No part hanging loose or damaged. Check also 1.6.1, 1.6.2 and 1.6.3	VC	4
3.1.2		Safety strap	Present, in proper condition	VC	4
3.1.3.1		Brake isolating cock	Operable	OP	3
3.1.3.2		Brake isolating cock	Position clear	VC, OP	3
3.1.4		Empty/loaded or G/P changeover device	Operable	OP	3
3.1.5		Brake release pull	Present and unbroken	VC	3

¹ VC = visual check; M = measurement; HT = hammer test; OP = operate; PM = pull or move the components

Code no.	Wagon	Component	Quality requirement	Control criteria ¹	Irregularity class
3.2.1	All wagons	Cast-iron brake block	Present, unbroken; thickness above the required minimum	VC, M	3
3.2.2		Composite brake block	Present, no radial crack from friction surface through to plate edge, no visible crumbling of more than one quarter of the block length. Thickness above the required minimum. No detachment of friction material from the back plate in excess of 25 mm and no cracking in excess of 25 mm in the direction of the wheel circumference.	VC, M	3
3.2.3		Friction components	Not projecting laterally	VC	4
3.2.4.1	All wagons	Inspection groove on the brake discs	Inspection groove completely visible	VC	3
3.2.4.2		Brake disc fixing	Suitable brake disc fixing	VC	5
3.2.4.3		Brake disc	No cracks > l/2 as per diagram	VC	3
3.2.4.4		Brake disc	No cracks in cross-section	VC	5
3.2.4.5		Cooling bars	Undamaged, no cracks	VC	3
3.2.4.6		Circular cooling fins	Undamaged, no cracks	VC	3
3.2.5		Brake linings	Present, not cracked	VC	3
3.2.6		Brake indicator	Suitable indication	VC	4
3.3.1.1	All wagons	Main brake pipe	Operable	VC	4
3.3.2.1	All wagons	Brake couplings	Present, intact	VC	3
3.3.2.2	All wagons	Brake couplings	Only one coupler plugged in, with the other secured in holder	VC	3
3.3.3	All wagons	Coupler holder	Present, operable	VC	3
3.3.4		Air brakes	Isolated brakes labelled accordingly	VC	3
3.3.5.1		Stopcock	Operable, airtight, not forced, handle present	VC, OP	5
3.3.5.2		Stopcock, stopping device	Present and obviously in good condition	VC	4
3.3.6.1		DET	Operational, switched on	VC	3
3.3.6.2		DET	Airtight	VC	3
3.3.6.3		DET	Detector's connection hose airtight	VC	4
3.4.1	All wagons	Spark arrestor plate	Present and not holed by rust	VC	4
3.4.2		Spark arrestor plate	Properly attached	VC	4

¹ VC = visual check; M = measurement; HT = hammer test; OP = operate; PM = pull or move the components

Code no.	Wagon	Component	Quality requirement	Control criteria ¹	Irregularity class
3.4.3	For the transport of dangerous goods in non- bogie wagons where RID regulations call for use of spark arrestor plates	Spark arrestor plate	Wagon must bear conventional symbol shown in Appendix 11 to the GCU, point 2.10 (spark arrestor plate authorised).	VC	5
3.5.1	All wagons fitted	Hand brake	Visibly operable	VC	3
4.1.1	All wagons	Underframe	No visible distortion; not buckled	VC	5
4.1.2		Solebar, headstock and intermediate crossbar	Not broken, cracks < 1/2 width of flange, longitudinal cracks < 100 mm near the suspension brackets, elsewhere < 150 mm; no cracking at visible welds	VC, M	4
4.2.1	All wagons	Axle guard	No distortion constituting a safety hazard	VC	5
4.2.2		Axle guard	Not broken	VC	5
4.2.3.1		Axle guard	Fastening effective, not loose	VC	5
4.2.3.2		Axle guard	No loose rivets or bolts on fastening	VC	3
4.2.4.1		Axle guard	No cracks extending more than ¼ of horizontal section	VC, M	4
4.2.4.2		Axle guard	No cracks	VC	3
4.2.4.2		Axle guard	No cracks	VC	3
4.2.4.3		Axle guard	No cracks close to or running towards a fastening point	VC	5
4.3.1	All wagons	Axle guard tie bar	Present, neither broken nor visibly distorted	VC	4
4.4.1.1	All wagons	Check plate (bogie wagon)	No check plate missing per axle	VC	3
4.4.1.2		Check plate (bogie wagon)	Not more than one check plate missing per axle	VC	4
4.4.1.3		Check plate (non-bogie wagon)	Present	VC	5
4.4.2	All wagons with Y bogies	Hard manganese wear plates	Secured, present	VC	4
4.5.1	All wagons fitted	Suspension bracket	In good condition, correctly secured	VC	5

¹ VC = visual check; M = measurement; HT = hammer test; OP = operate; PM = pull or move the components

Code no.	Wagon	Component	Quality requirement	Control criteria ¹	Irregularity class
4.6.1.1	All wagons	Bogie/underframe connection	Intact, not displaced; connection and fastening components present and effective	VC	5
4.6.1.2	All wagons	Bogie/underframe connection (bogie pivot kingpin)	Complete and effective	VC	4
4.6.2.1		Earthing strap	All present, undamaged, tight	VC	3
4.6.2.2		Earthing strap	At least 1 present and effective	VC	3
4.7.1	All wagons	Bogie frame	Not cracked or visibly distorted	VC	4
4.7.2		Bogie frame	No broken components	VC	5
4.7.3.1	All wagons with Y bogies	Bogie/frame connection	No missing or broken screws on inner longitudinal beam fastenings	VC	3
4.7.3.2	All wagons with Y bogies	Bogie/frame connection	No more than one missing or broken screw on inner longitudinal beam fastenings on the same axle	VC	5
4.8.1.1	All wagons	Side bearer	Not broken (no missing part)	VC	4
4.8.1.2		Side bearer	Not broken (missing part)	VC	5
4.8.2		Side bearer spring	No broken	VC	4
4.8.3		Side bearer fastening	Complete and effective	VC	3
4.9.1	All wagons	Friction surface of damper system	Not lubricated	VC	4
5.1.1	All wagons	Buffer types at each end of the wagon	Obviously of the same type	VC	4
5.1.2		Buffer height	Within tolerance range	VC, M	5
5.2.1	All wagons	Buffer head	Present, not broken, distorted but functional; rectangular buffer heads not twisted	VC	5
5.2.2.1		Buffer head	Fewer than 1/3 of bolts or rivets loose	VC	4
5.2.2.2		Buffer head	No loose bolts or rivets	VC	3
5.2.3.1		Buffer head contact surface	Lubricated if the two buffer heads which are in contact are made of metal	VC	5
5.2.3.2		Buffer head contact surface	No grooving	VC, M	5
5.2.4.1		Buffer head insert or plastic plate	Present, not broken, not cracked	VC	5
5.2.4.2		Buffer head insert or plastic plate	No crumbling/melding	VC, M	4
5.2.4.3		Buffer head insert or plastic plate	Fastening complete	VC	5
5.3.1	All wagons	Plunger	Present, not broken	VC	5
5.3.2.		Plunger	Not cracked at the transition to buffer head	VC	5
5.3.3.1		Plunger	No longitudinal cracking; still capable of guiding buffer	VC	5
5.3.3.2		Plunger	Operation not jeopardized, no grooving	VC, M	5

¹ VC = visual check; M = measurement; HT = hammer test; OP = operate; PM = pull or move the components

Code no.	Wagon	Component	Quality requirement	Control criteria ¹	Irregularity class
5.4.1	All wagons	Buffer guide	Present, not broken	VC	5
5.4.2		Buffer guide	Not cracked at transition to buffer base	VC	5
5.4.3.1		Buffer guide	No longitudinal cracking; still capable of guiding plunger	VC	5
5.4.3.2		Buffer guide	Operation not jeopardized, no grooving	VC, M	5
5.4.4.1		Buffer guide securing bolts	Tight (less than 2 bolts loose)	VC, PM	5
5.4.4.2		Buffer guide securing bolts	All bolts present	VC, PM	3
5.4.4.3		Buffer guide securing bolts	Tight (no bolts loose)	VC, PM	3
5.5.1	All wagons	Buffer spring	Functional, with compliant dimensions, unbroken. No buffers slack enough to be depressed by hand by more than 15 mm or neither of the two buffers able to be depressed.	VC, M	4
5.5.2	Marked wagons	Anti-crash components	Not triggered	VC	5
5.5.3	Marked wagons	Marking for anti-crash components	Present in its entirety, visible	VC	4
5.6.1.1	All wagons	Screw coupler	Present in its entirety and undamaged	VC	3
5.6.1.2	All wagons	Screw coupler	Fit for use and lubricated	VC	3
5.6.2		Hook for hanging coupler on when not in use	Present, fit for use, undamaged	VC	3
5.6.3		Looped coupling link	Hanging from hook	VC	3
5.7.1.1	All wagons	Draw hook	Serviceable, not broken or cracked	VC	3
5.7.1.2		Draw hook	Not twisted	VC	3
5.8.1	All wagons	Other draw gear parts	Present, not broken or cracked, no abnormal projection	VC	4
5.8.2		Coupling	Train correctly coupled	VC	4
5.9.1	All wagons	Long-stroke damper	Effective, sliding element in central position, undamaged	VC	4
5.9.2		Marking of danger points	Present	VC	4
6.1.1.1		Wagon number	Present, legible, complete	VC	4
6.1.1.2	Wagons with exchange codes beginning with a digit from 0 to 3	"RIV" sign, "TEN" + "GE" or acceptance marking ("TEN" + "G1", country acronym in approval plate)	Present, legible	VC	4

¹ VC = visual check; M = measurement; HT = hammer test; OP = operate; PM = pull or move the components

Code no.	Wagon	Component	Quality requirement	Control criteria ¹	Irregularity class
6.1.1.3	Wagons with exchange codes 41, 43, 45, 81, 83 or 85	Agreement plate or an acceptance marking ("TEN- CW", country code in approval plate)	Present, legible, complete	VC	4
6.1.1.4	All wagons	Tare	Present, legible, complete	VC	4
6.1.1.5		Holding force of parking brake	Present, legible, complete	VC	4
6.1.1.6		Load limits	Present, legible, complete	VC	4
6.1.1.7	Tank wagons	Capacity	Present, legible, complete	VC	4
6.1.1.8	All wagons	VKM or full address of the keeper	Present, legible, complete	VC	4
6.1.1.9	All wagons	Length-over-buffers	Present, legible, complete	VC	4
6.1.1.10	Wagons with ladders	High-voltage warning sign	Present, visible	VC	4
6.1.1.11	Container wagon	Specific marking	Present, visible	VC	4
6.1.2.1	All wagons	Inscription on the maintenance plate	Present, visible, complete	VC	4
6.1.2.2		Overhaul period (when appropriate+ "3 M" if marked)	Not expired, correctly labelled in accordance with Annex 8	VC	3
6.1.2.3		Overhaul period ≤ 6 months + "3 M"	Not expired, correctly labelled in accordance with Annex 8	VC	4
6.1.2.4		Overhaul period > 6 months + "3 M"	Not expired, correctly labelled in accordance with Annex 8	VC	4
6.1.3.1	All relevant wagons	Body framework	No damage	VC	3
6.1.3.2		Body framework	No damage which might compromise safety	VC, M	5
6.1.4.1	All relevant wagons	Walls	Secure, in good condition	VC	3
6.1.4.2		Walls	No damage which might cause goods to become damp or be lost	VC	4
6.1.5.1	All relevant wagons	Floor	Secure, watertight	VC	3
6.1.5.2		Floor	Secure, watertight, no risk of loss of load	VC	4
6.1.6.1	All relevant wagons	Doors and sliding walls	Fully closed and locked	VC	5
6.1.6.2		Doors and sliding walls	Present, not derailed, gauge not fouled	VC, M	5
6.1.6.3		Doors and sliding walls	Guiding and locking elements in good condition	VC	3

¹ VC = visual check; M = measurement; HT = hammer test; OP = operate; PM = pull or move the components

Code no.	Wagon	Component	Quality requirement	Control criteria ¹	Irregularity class
6.1.6.4		Doors and sliding walls	Guiding and locking elements in good condition and not compromising safety or causing a loss of load	VC	5
6.1.6.5	E, Ea	Doors	Undamaged	VC	3
6.1.6.6		Doors	No damage compromising operating safety	VC	5
6.1.7.1	All wagons	Ladders, gangways, guard rails	Operational	VC	4
6.1.7.2		Steps	Present (where clearly necessary)	VC	4
6.1.7.3		Steps	No damage representing a safety hazard for staff, not torn off, deformation within tolerated limits	VC, M	4
6.1.7.4		Handles	Present, no damage representing a safety hazard for staff, not torn off, deformation within tolerated limits	VC, M	4
6.1.7.5		Inscription plates, folding plates and label holders	Secured	VC	4
6.1.7.6		Inscription plates, folding plates and label holders	Present	VC	3
6.1.7.7		Loose wagon components	Present as marked on wagon	VC	3
6.1.7.8		Loose wagon components	Secured	VC	4
6.1.7.9		Signal brackets, rope eyes	Present, operable	VC	3
6.1.8.1	Covered wagons	Interior fittings	Undamaged, operable	VC	3
6.1.8.2	Covered wagons	Interior fittings	Undamaged, operable. If damaged unable to be repaired	VC	5
6.2.1.1	Covered wagons	Ventilation flaps	Present, undamaged	VC	3
6.2.1.2		Ventilation flaps	No damage compromising safety / load integrity or causing the gauge to be fouled	VC, M	5
6.2.2.1		Control gear, shutter retaining bracket	Securely hooked, not distorted, not loose	VC	3
6.2.2.2		Control gear, shutter retaining bracket	Not fouling the gauge	VC, M	5
6.2.3		Roof	Undamaged, watertight	VC	4
		Weatherboard	Present, undamaged, not loose	VC	4
6.2.4.1		Convertible roof	Secured and closed	VC	5
6.2.4.2		Convertible roof	Not derailed	VC	5
6.2.4.3		Visible operating parts	Present, undamaged, effective	VC	4

¹ VC = visual check; M = measurement; HT = hammer test; OP = operate; PM = pull or move the components

Code no.	Wagon	Component	Quality requirement	Control criteria ¹	Irregularity class
6.3.1.1	Open wagons	Side walls and end flaps	Undamaged, closed, watertight	VC	3
6.3.1.2		Side walls and end flaps	Undamaged, watertight and closed. If damaged: no risk of loss of load	VC	4
6.3.1.3		Side walls and end flaps	Undamaged, watertight and closed. If damaged: no risk of fouling gauge	VC	5
6.3.2.1	All wagons	Closing and operating gear of end flaps (pin, camshaft, retaining hook and shaft support)	Present, no fractures or cracks, effective	VC	3
6.3.2.2		Closing and operating gear of end flaps (pin, camshaft, retaining hook and shaft support)	Present, no fractures or cracks, effective If damaged/missing: not compromising safety	VC	5
6.3.3.1		Cantrail	Not damaged or distorted	VC	3
6.3.3.2		Cantrail	Not damaged or distorted. If broken or distorted: no risk of fouling gauge	VC	5
6.4.1.1	Flat wagons	Side and end drop walls, folded down	Secured	VC	5
6.4.1.2		Side and end drop walls, folded down (not permitted under Table 3 of the Loading Guidelines)	Raised	VC	5
6.4.1.3		Side and end drop walls	Not distorted	VC, M	3
6.4.1.4		Side and end drop walls	Not damaged or distorted. If damaged or distorted: no risk of loss of load	VC	4
6.4.1.5		Side and end drop walls	Not distorted. If distorted: no risk of fouling gauge	VC	5
6.4.2.1		Hinges, pins, securing bolts	Present, undamaged, operative	VC	3
6.4.2.2		Hinges, pins, securing bolts	Present, undamaged, operative. If missing or damaged: without compromising safety or risking any loss of load	VC	4
6.4.3.1		Stanchions (pivoting, retractable, detachable), stanchion sockets, holders and supports	Provided as necessary	VC	5

¹ VC = visual check; M = measurement; HT = hammer test; OP = operate; PM = pull or move the components

Code no.	Wagon	Component	Quality requirement	Control criteria ¹	Irregularity class
6.4.3.2		Stanchion (pivoting, retractable, detachable), stanchion sockets, holders and supports	Not fouling the gauge	VC	5
6.4.3.3		Stanchion (pivoting, retractable, detachable), stanchion sockets, holders and supports	Intact	VC	4
6.4.3.4		Stanchion chain	Hooked up	VC	4
6.4.3.5		Stanchion fasteners	Effective	VC	4
6.4.4.1		Bolsters	Intact	VC	3
6.4.4.2		Bolsters	Secured by stanchions or load	VC	4
6.5.1.1	Tank wagons	Tank cradle	No crack extending > 1/4 across the cross-section	VC, M	4
6.5.1.2		Tank cradle	No cracks in weld seams	VC	4
6.5.1.3		Tank cradle	All bolts or rivets securing the tank body to cradle present	VC	4
6.5.1.4		Tank cradle	90% of bolts or rivets securing the tank body to cradle present	VC	4
6.5.2.1		Tank body	Intact, no leaks or loss of load	VC	5
6.5.2.2		Tank body	No sharp-edged distortion (without loss of load)	VC	4
6.5.2.3		Tank full, RID load	Tank test deadline not expired, no "L" marking	VC	4
6.5.2.4		Tank full, RID load	Tank test deadline not expired, no "L" marking	VC	5
6.5.2.5		Tank empty, not cleaned, RID load	Tank test deadline not expired, no "L" marking	VC	4
6.5.2.6		Tank full, RID load	Tank test deadline not expired, "L" marking	VC	5
6.5.2.7		Tank empty, not cleaned, RID load	Tank test deadline not expired, "L" marking	VC	4
6.5.3.1		Tank equipment	Tank cladding, sunroof and insulation undamaged	VC	4
6.5.3.2		Tank equipment	Tank cladding, sunroof and insulation securely fastened	VC	5
6.5.5.1	Tank wagons	Reinforcement, filling and emptying equipment (underside)	No leakage of load	VC	5
6.5.5.3		Valves or spouts (underside)	Undamaged	VC	4

¹ VC = visual check; M = measurement; HT = hammer test; OP = operate; PM = pull or move the components

Code no.	Wagon	Component	Quality requirement	Control criteria ¹	Irregularity class
6.5.5.1	Tank wagons	Reinforcement, filling and emptying equipment (underside)	No leakage of load	VC	5
6.5.5.3		Valves or spouts (underside)	Undamaged	VC	4
6.5.5.4		Lower screw cap (except outside gas pipes), RID load	Present and in use, tightly closed	VC	4
6.5.5.5		Lower screw cap (except outside gas pipes), non-RID load	Present and in use, tightly closed	VC	3
6.5.5.6		Lower blind flange	Present	VC	4
6.5.5.7		Lower blind flange, RID load	No securing bolt missing or loose	VC, PM	4
6.5.5.8		Lower blind flange, non-RID load	No securing bolt missing or loose	VC, PM	3
6.5.5.9		Lower blind flange	Not more than one securing bolt missing or loose	VC, PM	4
6.5.5.10		Bottom valve indicator device, loaded wagon, and empty wagons that have not been cleaned (RID load)	In closed position	VC	5
6.5.5.11		Bottom valve indicator device, empty wagon (non- RID load)	In closed position	VC	3
6.5.5.12		Emergency control bolt for the bottom valve	Not screwed in the valve body	VC	5
6.5.5.13		Lower filling and emptying equipment	In closed position	VC	5
6.5.5.14		Lower filling and emptying equipment	Visible locking devices effective	VC	4
6.5.6.1	Tank wagons	Reinforcement, filling and emptying equipment (topside)	No loss of load or gas leakage (except ventilation device)	VC	5
6.5.6.2		Dome cover	Present, closed, visibly locked	VC	5
6.5.6.3		Other upper closing devices	Properly locked	VC	4
6.6.1.1	e.g. Rils, Tams	Sheeting	Closed, locked	VC	5
6.6.1.2		torn, holed sheeting ≤ 30 mm	Undamaged	VC, M	3
6.6.1.3		torn, holed sheeting > 30 mm	Undamaged	VC, M	5
6.6.2.1	e.g. S(a)hi	Hood	Closed, locked	VC	5
6.6.2.2	e.g. S(a)hi	Hood	Not derailed	VC, PM	5
6.6.3.1	e.g. Saad	End gangway	Undamaged	VC	4
6.6.3.2	e.g. Saad	End gangway	Locked at both ends	VC	5

Code no.	Wagon	Component	Quality requirement	Control criteria ¹	Irregularity class
6.6.3.3		Fastening devices	Effective	VC	4
6.6.3.4		Wheel scotches	Undamaged	VC	3
6.6.4.1	ACTS wagons	Swivel frame	Undamaged	VC	4
6.6.4.2		Locking device to prevent frame from swiveling	Effective, locked	VC	5
6.6.4.3		Pneumatic monitoring system on the swivel lock	In service (unless labelled otherwise)	VC	4
6.6.4.4		Pneumatic monitoring system on the swivel lock has triggered	Swivel lock effective and locked	VC	3
6.6.4.5		Device to prevent container lifting	Effective and secured	VC	5
6.6.4.6		Device to prevent container displacement	Effective	VC	5
6.6.5.1	Car-carrying wagons	Lifting equipment, crossover gangways	Undamaged	VC	4
6.6.5.2		Wheel scotch, wheel guides, crank handle	Undamaged	VC	3
6.6.5.3		End boards, crossing gangways	Raised and secured – if necessary	VC	4
6.6.5.4		Upper loading deck	Indicating device folded away	VC	4
6.6.5.5		Upper loading deck	Secured	VC	5
6.6.5.6		Upper loading deck	Lying on supporting brackets	VC	5
6.6.5.7	Loaded car-carrying wagons	Upper loading deck	No fouling of the gauge	VC	5
6.6.5.8		Gangways above central axles	Fully maneuverable, distance between wheel and gangway > 100 mm	VC, M	5
6.6.5.9	Empty car-carrying wagons	Crossover plates on central axles	Neither distorted, broken, nor cracked. No missing parts	VC	4
6.6.5.10	Loaded car-carrying wagons	Crossover plates on central axles	Neither distorted, broken, nor cracked. No missing parts	VC	5

Code no.	Wagon	Component	Quality requirement	Control criteria ¹	Irregularity class
6.6.6.1	Empty self-discharging wagons	Axial flap	Closed and locked	VC	3
6.6.6.2	Loaded self-discharging wagons	Axial flap	Closed and locked	VC	4
6.6.6.3	Empty self-discharging wagons	Lateral flap	Closed and locked	VC	4
6.6.6.4	Loaded self-discharging wagons	Lateral flap	Closed and locked	VC	4
6.6.7.1	E.g. Snps, Roos, Ealos	Securing equipment not in use	Suitably and adequately fixed and secured	VC, OP	4
6.7.1.1	Container Wagons	Seating device not in use	Locked, intact	VC	3
6.7.1.2		Seating device in use	Locked, intact	VC	5
6.7.1.3		Spigot not in use	Intact	VC	3
6.7.1.4		Spigot in use	Triggered, intact	VC	5
6.7.2		Pivot of trailer coupling in the trestle	Locked	VC	5
6.7.3		Seating device not used	Locked	VC	3
6.7.4		Seating device wheel	Locked, with no risk of fouling the gauge	VC	5
6.7.5.1		Moving parts	Locked	VC	3
6.7.5.2		Moving parts	Fixed, with no risk of fouling the gauge	VC	5
6.7.6.1		Anti-crash system of seating device in use	Non-deformed	VC	5
6.7.6.2		Anti-crash system of seating device not in use	Non-deformed	VC	4

¹ VC = visual check; M = measurement; HT = hammer test; OP = operate; PM = pull or move the components

Code no.	Component	Quality requirement	Control criteria ¹	Irregularity class
7.1.1	Load	Not displaced	VC	5
7.1.2	Distribution of load (3.3)	Body horizontal, showing no signs of poor distribution	VC	5
7.1.3	Packages, bales, bundles, stacks (1.5)	Correctly stowed and tied together	VC	4
7.1.4	Narrow cylindrical objects (1.5)	Adequately tied	VC	4
7.1.5.1	Loading gauge (4.1)	Not fouled	VC, M	5
7.1.5.2	Loading gauge	Permissible fouling of gauge marked	VC	5
7.1.6	Load projecting beyond headstock (4.2)	No encroachment on reserved spaces	VC, M	5
7.1.7.1	Load limits (3.2), visual observation	Body showing no sign of overloading, buffers level, sufficient clearance between spring buckle and solebar	VC, M	5
7.1.7.2	Load limits (3.2), otherwise recorded	No discrepancy between consignment data and load limits. Measurement and diagnostics data are within tolerances	VC, M	5
7.1.8	Buffer wagon (4.3)	Sufficient clearances between loads or between buffer wagon and load	VC, M	5
7.1.9	Sheeting, net (6.1, 6.2)	Conditions of use adhered to	VC	4
7.1.10	Loss of load	Conditions of use adhered to. If damaged: without risk of loss of load	VC	5
7.2.1	Load projecting beyond walls or sides of wagon (5.4.1)	Adequately retained	VC	5
7.2.2	Leaning load (2.3)	Not causing damage to structural elements of wagon, or obstructing their functioning	VC	4
7.2.3.1	Load secured by stanchions (2.5 and 5.4.1)	Adequately retained	VC, M	5
7.2.3.2	Transverse lashing ropes between stanchions (2.5)	Present where required	VC	5
7.2.3.3	Load pressing against stanchions (2.5)	No distortion of stanchions	VC	5
7.2.3.4	Heavy load or one which may damage the side stanchions should it move lengthways (2.5)	Securely wedged, not touching stanchions	VC	4
7.2.4	Scotches fastened with nails (5.4.3)	Suitable, effective and correctly fixed to the floor	VC	5
7.2.5.1	Direct or indirect fastenings (5.4.4, 5.5.4)	Made from suitable and approved materials	VC	5
7.2.5.2		Sufficient and correctly fastened	VC	5
7.2.5.3		Not slack	VC	4

¹ VC = visual check; M = measurement; HT = hammer test; OP = operate; PM = pull or move the components

Code no.	Component	Quality requirement	Control criteria ¹	Irregularity class
7.2.6.1	Bolsters, timbers, stretchers stowing material (5.5.5, 5.6.2, 5.8.1)	Adapted to load and visibly well positioned and secure	VC	5
7.2.6.2	Loading tackle and stowing material	Tidied away	VC	3
7.2.7	Potentially hazardous residues	Residues removed	VC	5
7.2.6.1	Bolsters, timbers, stretchers stowing material (5.5.5, 5.6.2, 5.8.1)	Adapted to load and visibly well positioned and secure	VC	5
7.2.6.2	Loading tackle and stowing material	Tidied away	VC	3
7.2.7	Potentially hazardous residues	Residues removed	VC	5
7.3.1	Load stability (5.1)	Ensured	VC	5
7.3.2	Goods which may be lifted by air flow, e.g. light scrap and light boards (5.2.1, 5.3.2)	Sufficiently well covered	VC	5
7.3.3.1	Goods which may fall off (vibrations, impacts) (5.2.2)	Sufficient clearance between the goods and the top of the wagon sides	VC	5
7.3.3.2	Height of dome-shaped load	Compliant with dimensions	VC	5
7.3.4	Stacked goods (5.8)	Correctly stacked, adequately bound and secured, not too high, correctly dovetailed, evenly distributed, clearances adhered to	VC	5
7.3.5.1	Load with small bearing surface (2.2)	Base provided in order to distribute weight over a greater area without damaging floor	VC	3
7.3.5.2	Concentrated loads	Suitable scotching materials of the correct dimensions	VC, M	5
7.3.6	Load liable to tip over (5.7)	Secured to avoid overturning	VC	5
7.3.7	Inclined load (5.7)	Adequately propped up	VC	5
7.3.8	Load liable to roll (5.6.1, 5.6.2)	Secured to prevent rolling	VC	5
7.3.9.1	Load able to slide lengthways (5.5.1)	Resting on suitable devices (skid, longitudinal slide arresters, lateral guide-pieces, etc.)	VC	4
7.3.9.2	Lateral guidance	In place, sufficient and with no risk of fouling the gauge or exceeding the load limit	VC, M	5
7.3.9.3	Necessary clearances	Provided	VC, M	3
7.3.9.4	Necessary room to slide	Limited in accordance with requirements	VC, M	4
7.4.1	Vehicle or machinery on wheels or caterpillar tracks (5.6.3)	Properly scotched and fastened	VC	5
7.4.2.1	Moving parts on load	Secured	VC	3
7.4.2.2	Moving parts on load	Secured. If not secured, no risk of the gauge being fouled	VC	5
7.4.3	Load supported on several wagons (5.9)	Loaded and secured in accordance with requirements	VC	5

¹ VC = visual check; M = measurement; HT = hammer test; OP = operate; PM = pull or move the components

Code no.	Component	Quality requirement	Control criteria ¹	Irregularity class
7.5.1	Locking device for dollies	Auxiliary equipment, present and effective	VC	4
7.5.2.1	ILU end doors not closed	Closed (unless load unit doors back-to-back)	VC	5
7.5.2.2	ILU end doors not properly closed	Door completely closed (unless load unit doors back-to-back)	VC	4
7.5.3	Inferior wedge parts	Intact	VC	5
7.5.4	Side wall, damaged cover	Intact, locked	VC	5
7.5.5.1	Cracked sheet, holed ≤ 30 mm	Intact	VC, M	3
7.5.5.2	Cracked sheet, holed > 30 mm	Intact	VC, M	5
7.5.5.3	Load	No damage from humidity to the load or loss of load	VC	4
7.5.6	Lock for sheets, side wall	Effective	VC	5
7.5.7	Frame/load-bearing parts	Not cracked or broken	VC	5
7.6.1.1	Tank cradle	No crack > Crack > 1/4 of the section	VC, M	4
7.6.1.2	Tank cradle	No crack in the weld seams	VC	4
7.6.2.1	Tank body	Tight: no leak or loss of load	VC	5
7.6.2.2	Tank body	No distortion with sharp edges and risk of loss of load	VC	4
7.6.3.1	Tank equipment	Tank cladding, sunroof, insulation not damaged	VC	4
7.6.3.2	Tank equipment	tank cladding, sunroof, insulation not loose	VC	5
7.6.4.1	Reinforcement, filling and emptying equipment, underneath	No loss of load	VC	5
7.6.4.2	Valves or spouts, underneath	Not damaged	VC	4
7.6.4.3	Screw cap, underneath, RID load	Tightly sealed	VC	4
7.6.4.4	Screw cap, underneath, non-RID load	Tightly sealed	VC	3
7.6.4.5	Blind flange, underneath	No missing	VC	4
7.6.4.6	Blind flange, underneath, RID load	No securing bolt missing or loose	VC, PM	4
7.6.4.7	Blind flange, underneath, non-RID load	No securing bolt missing or loose	VC, PM	3
7.6.4.8	Blind flange, underneath, non-RID load	Not more than one securing bolt missing or loose	VC, PM	4

¹ VC = visual check; M = measurement; HT = hammer test; OP = operate; PM = pull or move the components

Code no.	Component	Quality requirement	Control criteria ¹	Irregularity class
7.6.4.9	Bottom valve indicator device, LU, and empty wagons that have not been cleaned (RID load)	In “closed” position	CV	5
7.6.4.10	Bottom valve indicator device, LU, empty (non-RID load)	In “closed” position	CV	3
7.6.4.11	Bottom valve emergency control device	Not screwed in	CV	5
7.6.4.12	Filling and emptying equipment, underneath	“Closed” body	CV	5
7.6.4.13	Filling and emptying equipment, underneath	Efficient visible locking devices	CV	4
7.6.5.1	Reinforcement, filling and emptying equipment, above	No loss of load or of gas (does not concern ventilation devices)	CV	5
7.6.5.2	Dome cover	Present, closed, visibly locked	CV	5
7.6.5.3	Other upper reinforcements	Properly locked	CV	4
7.7.1	Load unit on carrier wagon	Within load requirements for wagon	VC	5
7.7.2	Load unit on carrier wagon	All corner castings engaged on their respective spigots	VC	5
7.7.3	Lowerable pins	All pins engaged and locked	VC	5
7.7.4	Semi-trailer	Air suspension emptied	VC	5
7.7.5	Semi-trailer	Raiseable underrun bumpers in correct position according to compatibility code of the recess wagon and with no contact with the carrier wagon	VC	3
7.7.6	Semi-trailer	On semi-trailers with P coding: no contact between semi- trailer and wagon other than through wheels and trestle	VC	4
7.7.7	Semi-trailer	On semi-trailers with N coding: no contact between semi- trailer and wagon other than through wheels, skids and longitudinal members in the intended support areas	VC	4
7.7.8	Scotching of semi-trailer	Correct scotching	VC	4
7.7.9	Loading into load unit	No visible signs of distortion	VC	5
7.8.1	Markings, coding for combined traffic	At least one plate present and legible	VC	5
7.8.2	Wagon coding indicating permissible load units	Marking present on wagon	VC	5
7.8.3	Load unit (ILU) with upper corner castings	CSC safety plate present	VC	4
7.8.4	“high voltage” warning sign on ILU with ladder access	Present	VC	4

¹ VC = visual check; M = measurement; HT = hammer test; OP = operate; PM = pull or move the components

Code no.	Component	Quality requirement	Control criteria ¹	Irregularity class
8.1.1	All wagons	No trace following derailment	VC	5
8.1.2	All wagons	No trace following abnormal shunting impact	VC	5
8.2.1	All wagons	No trace following flooding or damage due to poor weather	VC	5
8.2.2	All wagons	No trace of damage due to current start-up	VC	5
8.2.3	All wagons	No trace left by fire	VC	5

¹ VC = visual check; M = measurement; HT = hammer test; OP = operate; PM = pull or move the components

APPENDIX 9, ANNEX 6

Technical Transfer Inspection - List of irregularities noted on wagons and their loads

Station of transferee RU where the irregularity was detected: RU which carried out the technical transfer inspection:

Train number: Number of wagons inspected: Transferor RU:

Number of wagons damaged according to Annex 5:

Date	Wagon number (12 digits)	Description of irregularity	Code no. as per Annex 1 or 5	Class of irregularity	Label affixed by transferor railway?		Wagon loaded?		Gauge fouled as a result of irregularity?		Loaded wagon Loss of load possible?		Temporary repair or remedy effected by transferor railway in accordance with Annex 1			
					yes	no	yes	no	yes	no	yes	no	Necessary?		Performed?	
					6	7	8	9	10	11	12	13	14	15	16	17
1	2	3	4	5	6	7	8	9	10	11	12	13	14	15	16	17
					Σ Irregularities of class 3											
					Σ Irregularities of class 4											
					Σ Irregularities of class 5											

-reserved-

APPENDIX 9, ANNEX 7

Technical Transfer Inspection - Record and analysis of irregularities noted on wagon and loads

RU which carried out the quality inspection:

RU which carried out the technical transfer inspection:

Transferor RU:

Month/ year	Border station	Number of wagons inspected	Number of Class 3 to 5 irregularities						Comments
			Class 3		Class 4		Class 5		
			Σ	Col 4 x 0.125	Σ	Col 6 x 0.40	Σ	Col 8 x 1.0	
1	2	3	4	5	6	7	8	9	10

-reserved-

APPENDIX 9, ANNEX 8

Handling of wagons

1. With expired maintenance plate (or expired overhaul period)

Empty and loaded wagons with an expired maintenance plate (overhaul period exceeded) must be accepted.

Since wagons whose overhaul period is expired are no longer formally authorised to run, special measures must be taken at the time of expiry of the overhaul period to record and certify their fitness to run.

- 1.1 Until the expiry of the overhaul period, empty wagons and loaded wagons shall be treated in the same way. After expiry of this period, extended as appropriate by 3 months if the vehicle carries the “+3M” marking, a distinction shall be made between empty and loaded wagons. The details are given in the following diagram:

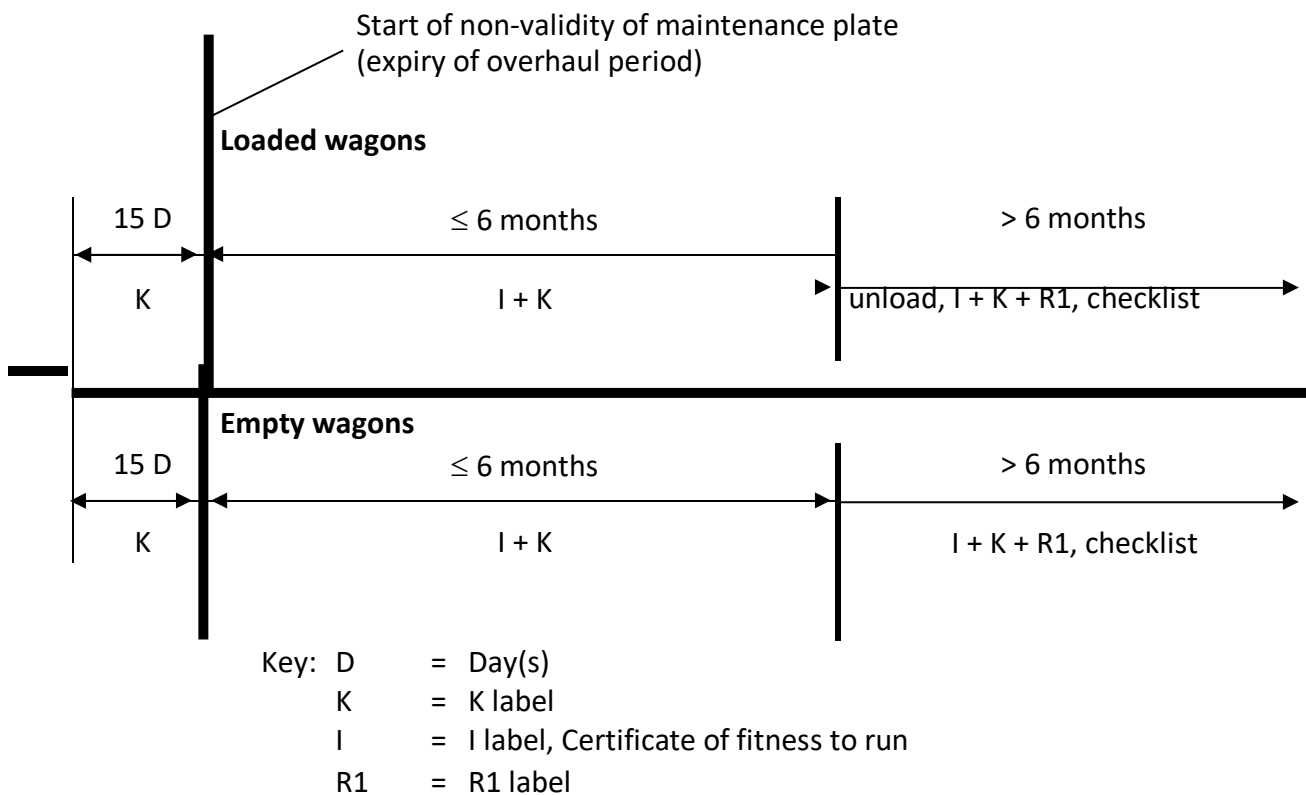

- 1.2 The issuing of an I label (certificate of fitness to run) is always based on an examination of fitness to run. For wagons whose overhaul period is exceeded by at least six months, this examination shall consist of a Technical Transfer Inspection as defined in section 2 (Appendix 9 to the GCU). If no damage or irregularity preventing the continued conveyance of the empty wagon without a speed limit is noted, the wagon should be labelled with K and I labels. These wagons, which are fit to run without restriction, shall be handled like damaged vehicles carrying labels and can therefore be included in or remain part of any scheduled train service.

Note concerning the procedure:

The initial examination by the qualified staff is crucial. This shall be carried out according to when the overall period expired (see diagram) and remains valid until the wagon arrives at the destination station or the workshop where the overhaul is to take place. In this case, qualified staff shall act in accordance with their own practical experience.

- 1.3 The wagons shall be removed from the train after reporting of damage or irregularities which have led to a speed restriction. Onward conveyance of these wagons is only authorised after repair or as special consignments (SC).
- 1.4 Empty and loaded wagons with an overhaul period that has been exceeded by over 6 months and under 5 years must be removed; loaded wagons must also be unloaded. Onward conveyance is only authorised once the examination of fitness to run has been conducted in accordance with the specific checklist (**Annex 9**).
- 1.5 The costs incurred are to be invoiced to the keeper in accordance with the GCU, article 22.4, first bullet point. The formal damage report described in Appendix 4 to the GCU is to be attached to the invoice as evidence. The costs shall include the cost of conducting the examination of fitness to run, the filling out and affixing of the I label and the cost of operation. If the overhaul period is exceeded, the invoice shall include all the resulting costs.

2. With exceeded load limit

Instructions on the procedure to follow for onward conveyance following identification of overloading and for taking the necessary corrective measures

In the event that the maximum load per wheel, wheelset or wagon has been identified as exceeded by means of technical measuring devices (train inspection devices) or on the evidence of visible signs on the wagon, or if other irregularities have been noted, the following procedure must be applied.

Once the wagon has been removed, the weight of the wagon, wheelset or wheel must be checked by means of scales should no data from the dynamic measurement systems in the infrastructure be available.

Wheelset overloading percentage:

On detection, a value “C” must be measured for the load, taking into account the accuracy of the means of measurement “p”. The overload percentage is calculated using the following formula:

$$\% \text{ overload} = 100 \times ((C(1-p^*)/\text{nominal load}) - 1)$$

* if the accuracy of the means of measurement is unknown, “p” = 0 is applied.

- If wheelset overload exceeds 2% and is less than or equal to 10%, the load must be rectified. A visual check shall be performed in accordance with the “overloading” checklist (Annex 9). The wagon shall be marked with the K label.
- If wheelset overload exceeds 10%, transshipment is required. Following a technical assessment, the wagon shall be marked with the K label in accordance with the “overloading” checklist (Annex 9) and conveyed empty to a workshop located nearby.

If the permissible wheelset load cannot be identified on the wheelset, the wagon must be conveyed to a workshop located nearby.

Wheelset markings

If wheelset overload is greater than 2%, the wheelset must be marked with a white cross on the axle.

Summary:

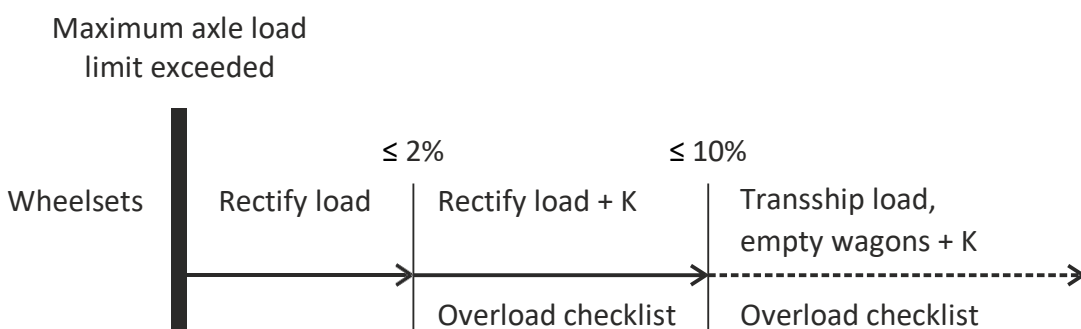

3. With exceeded concentrated load

Instructions on the procedure to follow for onward conveyance following identification of exceeded concentrated load and for taking the necessary corrective measures

- Visual assessment of wagon with exceeded concentrated load
- Calculation of load weight by means of scales or from information on the consignment note
- Calculation of exceeded concentrated load percentage compared to the inscriptions on the wagon in accordance with number 3.4 of the UIC Loading Guidelines, Volume 1

Exceeded concentrated load and procedure:

- If less than or equal to 5%, the overload is simply rectified.
- If greater than 5% and less than or equal to 20%, the overload must be rectified. A visual check shall be performed in accordance with the “exceeded concentrated load” checklist (Annex 9). The wagon shall be marked with the K label.
- If wheelset overload exceeds 20%, transshipment is required. Following a technical assessment, the wagon shall be marked with the K label in accordance with the “overloading” checklist (Annex 9) and conveyed empty to a workshop located nearby.

Summary:

Exceeded concentrated load

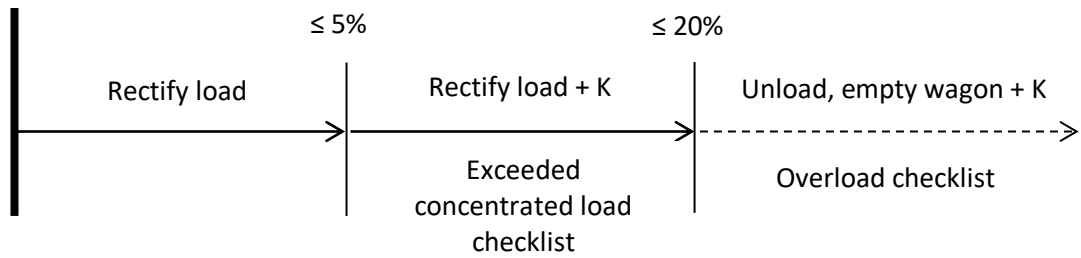
**4. With wheels displaying the criteria for thermal overload as per no. 1.2.2**

For wheels displaying indications of thermal overload as per no. 1.2.2 and not being marked as being able to withstand high thermal stresses,

- measure the widening of the inner faces (E value) at the running surface of the rail at 3 points, at distances of 120° , and verify no. 1.7.1.
- inspect the tread for isolated cracks in the cross-section
- Annex 12 (Traceability) must be completed.

5. Equipped with a DET (derailment detector)

- Tracing a tripped detector:

When a tripped detector is detected, the wagon (all axles) must be examined in accordance with the checklist (Annex 9) in order to determine the cause. If it has proved impossible to identify the cause, reset the display unit of the detector by pressing on the red flap of the trip indicator.

- DET not airtight (air leakage):

Isolate the detector using the handle and replace it as soon as possible.

- Yellow lever handle in a vertical position: detector tripped
- Yellow lever handle in a horizontal position: detector not tripped

Resetting:

The DET only resets itself automatically once the main brake pipe is fully drained; only then can the main brake pipe be refilled.

The trip indicator (red flap) remains visible at all times and must be reset manually once the pressure in the main brake pipe is zero.

After inspection of the wagon, the trip indicator may be reset.

APPENDIX 9, ANNEX 9

Checklists

These checklists must be followed in their entirety in addition to the criteria in Annex 1. Where applicable, reasons for unfitness to run must be indicated. The measured values must be documented for the purpose of traceability (Annex 12).

1. INSPECTION OF FITNESS TO RUN FOR WAGONS WITH AN EXPIRED MAINTENANCE PLATE

- **Reference:** Annex 8, point 1.4: empty wagon with a maintenance plate (overhaul period) that has been expired for at least 6 months and for a maximum of 5 years.
- **The measured values of the wheelsets must be documented for the purpose of traceability (Annex 12).**

1	2	3	4	5
Number	Question	Answer	Go to number	Comments
Provisions common to vehicles with individual axles and bogies				
1	Is the wagon marked with an interoperability sign conform to point 6.1.1.2 and 6.1.1.3 of Annex 1?	Yes No	2 12.2	
2	Is the loading gauge of the participating RUs respected?	Yes No	3 2.1	
2.1	Have the participating RUs agreed for the wagon to be handed over?	Yes No	3 12.2	
3	Do the wheelsets have an identification mark?	Yes No	3.1 12.2	Ask the keeper and wait for his written confirmation.
3.1	Does the keeper confirm that the overhaul date has not been exceeded?	Yes No	4 / 4.1 12.2	If not possible, 12.2
4	Does the wheel tyre thickness conform to the criteria of point 1.1.1 of Annex 1?	Yes No	5 12.2	Measure
4.1	Or Does the groove marking the minimum thickness for one-piece wheels conform to the criteria of point 1.2.1 of Annex 1?	Yes No	5 12.2	

Number	Question	Answer	Go to number	Comments
5	Are there signs of damage due to an incident, derailment, violent shunting impacts or thermal overload (with the exception of wheelsets marked as being able to withstand high thermal stresses)?	Yes No	5.1 5.2	
5.1	Do the values S_d , S_R , qR and E lie within the permissible limits and is there no sign that the wheels are misaligned with the axle?	Yes No	6 12.2	Measure (for the E value measure at 3 points)
5.2	Do the values S_d , S_R , qR and E lie within the permissible limits and is there no sign that the wheels are misaligned with the axle?	Yes No	6 12.2	Measure (for the E value measure at 1 point)
6	Does the distance between active surfaces (S_R) satisfy the following criteria: <ul style="list-style-type: none"> – no more than 1426 mm? – at least 1410 mm for a wheel diameter > 840 mm? – at least 1415 mm for a wheel diameter \leq 840 mm? 	Yes No	7 12.2	
7	Is the wagon clearly fitted with a uniform type of suspension springs?	Yes No	8 12.2	
8	Does the buffer height lie within the permissible tolerances?	Yes No	9 12.2	Measure
9	Does the wagon have superstructures liable to rotate, be displaced or otherwise move during the journey?	Yes No	10 11	
10	Are there sufficient devices outwardly visible for securing moving superstructures and are they present and effective?	Yes No	11 12.2	
11	Is the wagon otherwise free of safety-critical damage or defects?	Yes No	12.1 12.2	
	Results of the examination of fitness to run		Measures	
12.1	The wagon may continue to run empty at the marked speed (with the brake isolated).		Fill out the Label I, indicate wagon as fit to run.	
12.2	The wagon may not be included in trains in its present condition.		Do not fill out the Label I, indicate wagon as unfit to run, giving reasons.	

2. INSPECTION OF FITNESS TO RUN FOR AN OVERLOADED WAGON (EXCEEDED LOAD LIMIT)

- **Reference:** Annex 8, point 2: procedure for onward conveyance following identification of overloading and for taking the necessary corrective measures.
- **The measured values of the wheelsets must be documented for the purpose of traceability (Annex 12).**

Wagon checklist for overloading

Inspection of wagon overloading	1. Wheelsets / running gear	<ul style="list-style-type: none"> • Wheelset: > 2% and ≤ 10% overload Perform visual check for damage • Wheelset: > 10% overload Perform visual check for damage and measure the three points after unloading the wagon (empty). • Running gear: Perform visual check for damage, deformation and cracks on the bogie frame.
	2. Springs	Perform visual check for damage, deformation and cracks on the suspension springs and spring suspension.
	3. Brake	Perform visual check for damage, deformation and cracks on the brake rigging
	4. Underframe	Perform visual check for damage, deformation and cracks on the underframe.
	5. Draw/pushing device	Perform visual check for damage, deformation and cracks on the draw and pushing device. Measure the height of the buffers.
	6. Wagon body	Perform visual check for damage, deformation and cracks on the wagon body.

3. INSPECTION OF FITNESS TO RUN FOR AN OVERLOADED WAGON (CONCENTRATED LOADS)

- **Reference:** Annex 8, point 3: procedure for onward conveyance following identification of overloading and for taking the necessary corrective measures.

Wagon checklist for exceeded concentrated loads

Inspection of wagon with exceeded concentrated loads	1. Underframe	Check visually for damage, deformation and cracks on underframe
	2. Draw/pushing device	Check visually for damage, deformation and cracks on draw and pushing device Measure the height of the buffers
	3. Wagon body	Check visually for damage, deformation and cracks on wagon body

4. INSPECTION OF FITNESS TO RUN IN THE EVENT OF IRREGULARITIES IN OPERATIONS

- **Reference:** Annex 1, code 8.1: additional handling of the wagon following irregularities in operations
- **The measured values of the wheelsets must be documented for the purpose of traceability (Annex 12).**

1	2	3	4	5
Number	Question	Answer	Go to number	Comments
Provisions common to vehicles with individual axles and bogies				
1	Is the wagon marked with an interoperability sign conform to points 6.1.1.2 and 6.1.1.3 of Annex 1?	Yes No	2 15.2	
2	Is the loading gauge of the participating RUs respected?	Yes No	3 2.1	
2.1	Have the participating RUs agreed for the wagon to be handed over?	Yes No	3 15.2	
3	Has the wagon derailed?	Yes No	5 4	
4	Has the wagon sustained an abnormal buffering shock or an impermissible operating shock?	Yes No	6 15.1	
5	Is the derailment speed known?	Yes No	7 / 7.1 7 / 7.1	To document in km/h
6	Is the buffering speed known?	Yes No	7 / 7.1 7 / 7.1	To document in km/h
7	Does the wheel tyre thickness conform to the criteria of point 1.1.1 of Annex 1	Yes No	8 15.2	To measure
7.1	or Does the groove marking the minimum thickness for one-piece wheels conform to the criteria of point 1.2.1 of Annex 1?	Yes No	8 15.2	
8	Do the values S_d , S_r , qR and E lie within the permissible limits?	Yes No	9 15.2	For value E , measure at three points.
9	Does the distance between active surfaces (S_R) satisfy the following criteria: – no more than 1426 mm? – at least 1410 mm for a wheel diameter > 840 mm? – at least 1415 mm for a wheel diameter \leq 840 mm?	Yes No	10 15.2	
10	Is the wagon clearly fitted with a uniform type of suspension springs?	Yes No	11 15.2	
11	Does the buffer height lie within the permissible tolerances?	Yes No	12 15.2	To measure
12	Does the wagon (or its load) have superstructures liable to rotate, be displaced or otherwise move during the journey?	Yes No	13 14	

1	2	3	4	5
13	Are there sufficient outwardly visible devices for securing moving superstructures (or their loads) and are they present and effective?	Yes No	14 15.2	
14	Is the wagon otherwise free of safety-critical damage or defects?	Yes No	15.1 15.2	
Results of the examination of fitness to run		Measures		
15.1	The wagon may continue to run at the marked speed as a special consignment.	Fill out the Label I, indicate wagon as fit to run.		
15.2	The wagon may not be included in trains in its present condition.	Do not fill out the Label I, indicate wagon as unfit to run, giving reasons.		

5. EXAMINATION OF THE ABILITY TO RUN OF WAGONS EQUIPPED WITH DET (DERAILMENT DETECTOR)

- **Reference:** Appendix 8, point 4, procedure for onward carriage following the tripping of a DET

Checklist of wagon with DET

Inspection of wagon after tripping of DET	1. Wheel	Perform visual check. Perform visual check for any signs of deformation or cracks on the running surface or on the flange
	2. Axles / running gear	Perform visual check for any signs of damage, deformation or cracks on the axles and the axle boxes
	3. Bogie	Perform visual check for any signs of damage, deformation or cracks on the bogies
	4. Connection between bogie and underframe	Perform visual check for any signs of damage, deformation or cracks on the connection between bogie and wagon body.

-reserved-

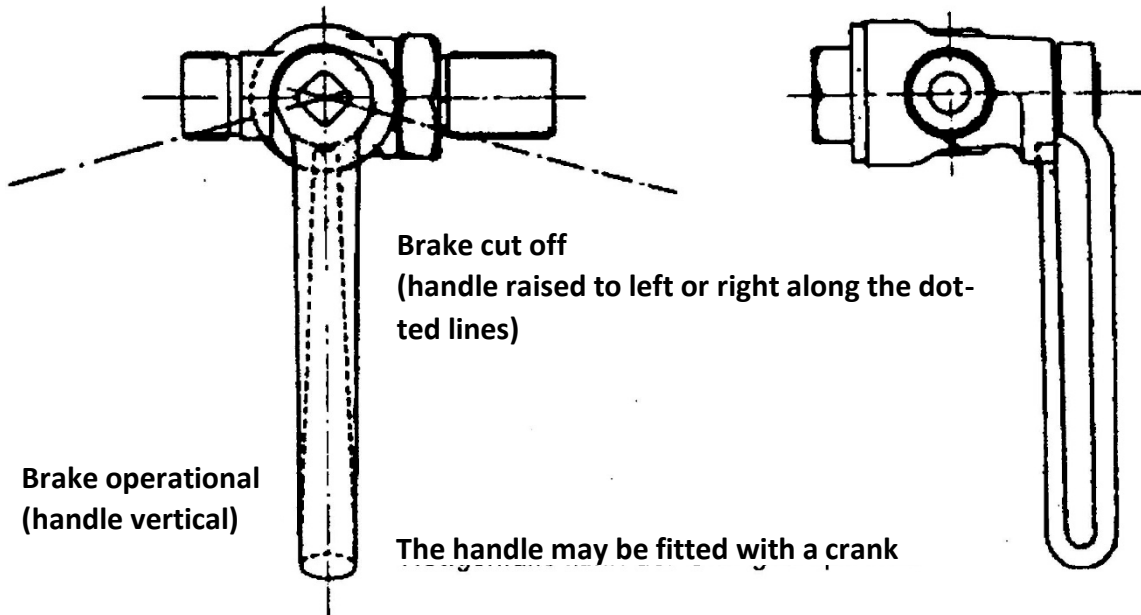
APPENDIX 9, ANNEX 10**Positions of the brake stopcock handle for compressed air brakes****Condition**

On wagons fitted with compressed air brakes, the brake stopcock handle must be pointing vertically downwards when the brake is operational. To cut off the brake, the handle must be turned to the left or right by a maximum of 90°. The handle must meet the conditions set out above.

-reserved-

LABEL K

(RU's symbol) As per catalogue of irregularities, GCU Appendix 9, Annex 1	Wagon Number <input style="width: 20px; height: 20px;" type="text"/> <input style="width: 20px; height: 20px;" type="text"/> <input style="width: 20px; height: 20px;" type="text"/> <input style="width: 20px; height: 20px;" type="text"/> <input style="width: 20px; height: 20px;" type="text"/> <input style="width: 20px; height: 20px;" type="text"/> <input style="width: 20px; height: 20px;" type="text"/> <input style="width: 20px; height: 20px;" type="text"/> - <input style="width: 20px; height: 20px;" type="text"/>	Label K	
Do not reload / To be repaired following			
1 Running Gear	2 Suspension	3 Brake	4 Wagon under-frame and bogie
5 Buffing and draw gear	6 Wagon body	7 Loads and load units	8 Miscellaneous
<input style="width: 20px; height: 20px;" type="text"/> <input style="width: 20px; height: 20px;" type="text"/> <input style="width: 20px; height: 20px;" type="text"/>	<input style="width: 20px; height: 20px;" type="text"/> <input style="width: 20px; height: 20px;" type="text"/> <input style="width: 20px; height: 20px;" type="text"/>	<input style="width: 20px; height: 20px;" type="text"/> <input style="width: 20px; height: 20px;" type="text"/> <input style="width: 20px; height: 20px;" type="text"/>	<input style="width: 20px; height: 20px;" type="text"/> <input style="width: 20px; height: 20px;" type="text"/> <input style="width: 20px; height: 20px;" type="text"/>
Other details _____			
Stamp of issuing office	Date of stamping	Signature	
For issuing RU's use			

blue, size roughly 148 x 210 mm

K labels serve to indicate that there is a problem with the wagon or load unit, but that these can – for the time being – continue to be operated. However, the problems must be resolved prior to reloading; any reloading of the wagon will lead to its withdrawal.

The defect code must be filled out completely in accordance with GCU Appendix 9, Annex 1:

1. Circle or tick the number of the defect group/category
2. Enter the exact defect number in the empty boxes

K labels are to be affixed to both sides of the wagon in a clearly visible position, close to the label-holder or on the inscription plates. The printed version of the K label must contain the data provided for by this annex.

LABEL R1

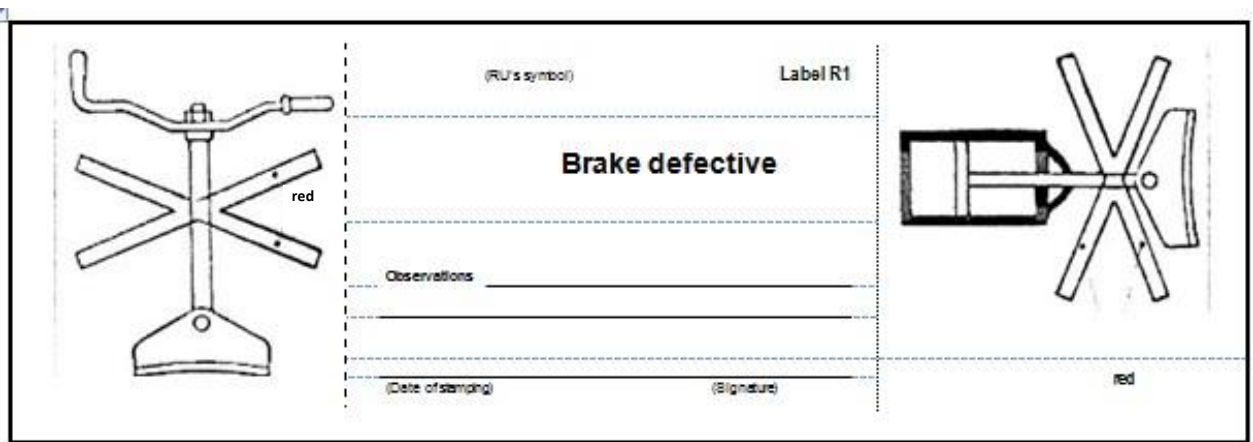



white, size roughly 105 x 210

Label R1 is used to mark wagons with defective brakes or brakes that must not be used for specific reasons. If the brake in question is the handbrake (operated from the wagon platform or from the ground) then the inapplicable right-hand part of the label should be removed, while if the air brake is defective, the left-hand part of the label R1 does not apply and should be removed accordingly.

Label R1 is to be affixed to both sides of the wagon close to the brake stop cock or near the braked weight marking.

LABEL U

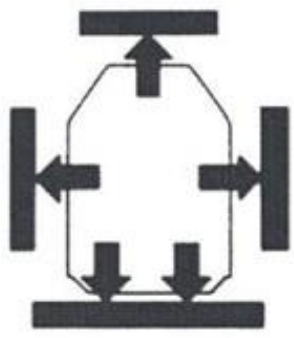
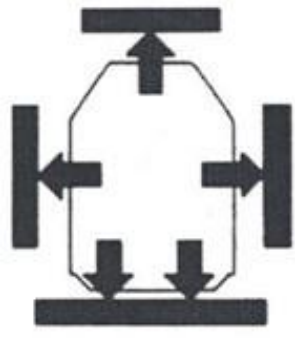
Label for Special Consignments

(RU's symbol)	Label U (RU's symbol)																																																																																
																																																																																	
For label-holder	For label-holder																																																																																
<table border="1" style="width: 100%; border-collapse: collapse;"> <tr> <th>Total load</th> <th>Load per metre</th> <th>Maximum axle load</th> </tr> <tr> <td style="text-align: center;">7+8 t</td> <td style="text-align: center;">9 t/m</td> <td style="text-align: center;">10 t</td> </tr> <tr> <td> </td> <td> </td> <td> </td> </tr> </table>	Total load	Load per metre	Maximum axle load	7+8 t	9 t/m	10 t				<table border="1" style="width: 100%; border-collapse: collapse;"> <tr> <th>Total load</th> <th>Load per metre</th> <th>Maximum axle load</th> </tr> <tr> <td style="text-align: center;">7+8 t</td> <td style="text-align: center;">9 t/m</td> <td style="text-align: center;">10 t</td> </tr> <tr> <td> </td> <td> </td> <td> </td> </tr> </table>	Total load	Load per metre	Maximum axle load	7+8 t	9 t/m	10 t																																																																	
Total load	Load per metre	Maximum axle load																																																																															
7+8 t	9 t/m	10 t																																																																															
Total load	Load per metre	Maximum axle load																																																																															
7+8 t	9 t/m	10 t																																																																															
(RU's symbol) / (no.)	(RU's symbol) / (no.)																																																																																
..... / /																																																																																
..... / /																																																																																
<table border="1" style="width: 100%; border-collapse: collapse;"> <thead> <tr> <th rowspan="2">Part</th> <th colspan="2">Lateral distance from wagon centre-line on</th> <th rowspan="2">Height above rail level</th> <th colspan="2">Longitudinal distance from end wheelset / bogie centre</th> </tr> <tr> <th>one side</th> <th>other side</th> <th>14 \varnothing_j mm</th> <th>15 $\varnothing_{j\alpha}$ mm</th> </tr> </thead> <tbody> <tr> <td> </td> <td style="text-align: center;">12a mm</td> <td style="text-align: center;">12b mm</td> <td style="text-align: center;">13 mm</td> <td> </td> <td> </td> </tr> <tr> <td>A</td> <td> </td> <td> </td> <td> </td> <td> </td> <td> </td> </tr> <tr> <td>B</td> <td> </td> <td> </td> <td> </td> <td> </td> <td> </td> </tr> <tr> <td>C</td> <td> </td> <td> </td> <td> </td> <td> </td> <td> </td> </tr> <tr> <td>D</td> <td> </td> <td> </td> <td> </td> <td> </td> <td> </td> </tr> </tbody> </table>	Part	Lateral distance from wagon centre-line on		Height above rail level	Longitudinal distance from end wheelset / bogie centre		one side	other side	14 \varnothing_j mm	15 $\varnothing_{j\alpha}$ mm		12a mm	12b mm	13 mm			A						B						C						D						<table border="1" style="width: 100%; border-collapse: collapse;"> <thead> <tr> <th rowspan="2">Part</th> <th colspan="2">Lateral distance from wagon centre-line on</th> <th rowspan="2">Height above rail level</th> <th colspan="2">Longitudinal distance from end wheelset / bogie centre</th> </tr> <tr> <th>one side</th> <th>other side</th> <th>14 \varnothing_j mm</th> <th>15 $\varnothing_{j\alpha}$ mm</th> </tr> </thead> <tbody> <tr> <td> </td> <td style="text-align: center;">12a mm</td> <td style="text-align: center;">12b mm</td> <td style="text-align: center;">13 mm</td> <td> </td> <td> </td> </tr> <tr> <td>A</td> <td> </td> <td> </td> <td> </td> <td> </td> <td> </td> </tr> <tr> <td>B</td> <td> </td> <td> </td> <td> </td> <td> </td> <td> </td> </tr> <tr> <td>C</td> <td> </td> <td> </td> <td> </td> <td> </td> <td> </td> </tr> <tr> <td>D</td> <td> </td> <td> </td> <td> </td> <td> </td> <td> </td> </tr> </tbody> </table>	Part	Lateral distance from wagon centre-line on		Height above rail level	Longitudinal distance from end wheelset / bogie centre		one side	other side	14 \varnothing_j mm	15 $\varnothing_{j\alpha}$ mm		12a mm	12b mm	13 mm			A						B						C						D					
Part		Lateral distance from wagon centre-line on			Height above rail level	Longitudinal distance from end wheelset / bogie centre																																																																											
	one side	other side	14 \varnothing_j mm	15 $\varnothing_{j\alpha}$ mm																																																																													
	12a mm	12b mm	13 mm																																																																														
A																																																																																	
B																																																																																	
C																																																																																	
D																																																																																	
Part	Lateral distance from wagon centre-line on		Height above rail level	Longitudinal distance from end wheelset / bogie centre																																																																													
	one side	other side		14 \varnothing_j mm	15 $\varnothing_{j\alpha}$ mm																																																																												
	12a mm	12b mm	13 mm																																																																														
A																																																																																	
B																																																																																	
C																																																																																	
D																																																																																	
(RU's symbol)	(RU's symbol) (no.)																																																																																
 /																																																																																
Separate and attach to consignment note																																																																																	

White or blue, size roughly 210 x 210/50 mm

Label U is used to indicate Special Consignments (SC) in accordance with number 7, Volume 1, of the Loading Guidelines. The provisions of UIC IRS 50502 apply to consignments of this kind. A further application is specified in Annex 8.

Label U is to be inserted in the label holder on both sides of the wagon.

-reserved-

APPENDIX 9, ANNEX 12

Traceability

The results of measurements by the user RU must be available in electronic format or on paper for a period of at least 2 years. The documentation remains as evidence of activity for the user RU.

Erfassung Radsatzdaten von Wagen im Betrieb
Saisie de données d'essieu de wagon en exploitation
Registration of axle data for operating wagon

Wagennummer: Numero du wagon: Wagon number:	<input type="text"/>	-	<input type="text"/>	Gattung: Type: Type:	<input type="text"/>			
Halter: Détenteur: Keeper:				E-Mail / Fax:				
Grund der Vermessung / Cause de la mesure / Reason for measurement:								
Entgleisung Deraillement Derailment	<input type="checkbox"/>	Thermische Überbeanspruchung Surcharge thermique Thermal overload	<input type="checkbox"/>	Lauffähigkeitsuntersuchung Examen d'aptitude à la circulation Fit-to-run inspection	<input type="checkbox"/>			
8L 7L	6L 5L	4L 3L	L		2L 1L			
2			R	1				
8R 7R	6R 5R	4R 3R	R		2R 1R			
Sh								
Sd								
qR								
	1L	2L	3L	4L	5L	6L	7L	8L
	1R	2R	3R	4R	5R	6R	7R	8R
Sh								
Sd								
qR								
E1								
E2								
E3								
S _R								
Vermessen von / Mesuré par / Measurements taken by:								
Name:				Vorname:				
Nom:				Prénom:				
Sumame:				First name:				
Tel. Nr:				Ort:				
N° de tél.:				Lieu:				
Tel. no.:				Location:				
Spurkranzlehre-Nummer: Numéro de jauge: Gauge no. (wheel flange):								
Spumesslehre-Nummer: Numéro de calibre de mesure: Gauge no. (back-to-back distance):								
Werte eingehalten? Valeurs respectées? Values compliant?	Ja Oui Yes	<input type="checkbox"/>	* Nein * Non * No	<input type="checkbox"/>	Schadensprotokollnummer: Numéro du procès verbal: Damage report no.:			
Massnahmen erforderlich? Suite à donner? Follow-up action required?	Ja Oui Yes	<input type="checkbox"/>	Nein Non No	<input type="checkbox"/>	Bemerkungen: Remarques: Remarks:			
Wenn Ja, welche? Si oui, laquelle? If so, what?								
Datum: Date: Date:				Unterschrift: Signature: Signature:				